

LEDko EXT M

Ultimo Aggiornamento:
17/11/2023



LEDko EXT M











Introduzione

● Abbiamo preso il nostro prodotto di punta e lo abbiamo reso più piccolo. Molto più piccolo. Siamo orgogliosi di presentarvi la nuova famiglia di prodotti Coemar, LEDko EXT M.

Grazie a LEDko EXT M possiamo ampliare la nostra offerta e rendere disponibile tutta la qualità che offriamo con LEDko, in un corpo molto più piccolo.

L'alta potenza non è sempre necessaria ed è per questo che è nato LEDko EXT M. Chiunque abbia bisogno di un profiler con un incredibile rapporto luce emessa/potenza deve avere il nostro nuovissimo LEDko EXT M. Abbiamo pensato a tutto, dall'ottica alle opzioni di montaggio, ai protocolli di comunicazione, per garantire che chiunque possa trovare il prodotto perfetto per le proprie esigenze.

Caratteristiche Principali

-  Profile Spot LED IP65 per installazione permanente all'aperto
-  58 W White COB LED (versione T/D)
● 58 W COB LED (versione VW)
-  CRI 80, CRI 90 o CRI > 95 (versione T/D)
● CRI > 98, TLCI 98 @ 3.200K, CRI 95, TLCI 97 @ 5.600K (versione VW)
-  CCT disponibili: 2.700 K, 3.000 K, 3.500 K, 4.000 K, 5.000 K (versione T/D)
● CCT: Bianco Variabile 2.800 K → 5.600 K (versione VW)
-  Proiezione omogenea del fascio di luce ed elevato flusso luminoso
-  Profile Zoom 15° - 30° or 19°, 26°, 36°, 50° Lens Tube
● Lo zoom proporzionale con ottica HD garantisce una proiezione chiara e vivida delle immagini
-  Sistema di sagomazione interno a 4 ghiottine
-  Alluminio estruso
-  Colori personalizzati su richiesta (opzionale)
-  Certificazione CE

Specifiche Generali	
● Sorgente LED	55W White COB LED (versione T/D), 55W COB LED (versione VW)
● Range CCT	● ● ● ● ● Bianco Fisso 2.700 K, 3.000 K, 3.500 K, 4.000 K, 5.000 K (versione T/D) ● ● ● ● ● Bianco Variabile 2.800 K → 5.600 K (versione VW)
● Media Resa Cromatica	CRI> 98, TLCI 98 @ 3.200K, CRI 95, TLCI 97 @ 5.600K
● Dimmer	Lineare da 100% a 0% (versione DMX)
● Lenti	Profile Zoom 15°-30° or 19°, 26°, 36°, 50° Lens Tube
● Sistema di sagomazione	Sistema di sagomazione a 4 ghigliottine regolabili sia per posizione radiale che per angolo di inclinazione
● Controllo flicker-free per telecamere/intervallo Hz	Sì, da 600 a 20.000 Hz (versione DMX)
● COB Calibrato	Sì
● L80 (ore all'80% di potenza)	50.000 Ore
● Proiezione di gobo	Sì
● Dimensioni del gobo	Diametro esterno del gobo= 26 mm Diametro massimo dell'immagine= 22 mm Spessore massimo del gobo= 2mm (gobo di vetro)

Specifiche Elettriche	
● Alimentazione AC	85-264 V, 47/63 Hz (su richiesta disponibile in altri voltaggi), auto-sensing
● Consumo Energetico	58 W Tipico - 0.28 A @ 230 V, 0.56 A @ 115 V - cos 0.9
● Connessione Elettrica	Cavo integrato di 0.5 m senza spina di alimentazione
● Connessione DMX	Ingresso e uscita XLR a 5 poli o connettore DMX a giunzione (versione DMX)

Specifiche Termiche	
● Temperatura ambientale di funzionamento	-25°C - +40°C
● Temperatura ambiente di stoccaggio	-30°C - +80°C
● Elettronica Termica Attiva	Gestione Termica Elettronica Attiva
● Raffreddamento	Raffreddamento a convezione silenzioso e senza ventole per installazioni acusticamente sensibili

Controlli	
● Protocolli	On/Off DMX512, RDM (Gestione remota dei dispositivi), Wireless (opzionale By LumenRadio)
● Configurazione RDM	Sì (solo versione DMX)
● Canali DMX	5 / 1 (versione T/D) 5 / 2 / 1 (versione VW)

Specifiche Fisiche	
● Opzioni di Montaggio	Forcella
● Materiali	Alluminio estruso
● Peso	Corpo: 2.8 Kg - Scatola di alimentazione: 0.96 Kg
● Lunghezza	351 mm
● Altezza	175 mm
● Larghezza	132 mm
● Grado di Protezione IP	IP65
● Opzioni di colore	Nero (standard), colori personalizzati su richiesta (opzionale)

Accessori Generali	
BC074A008	Portagobo in Metallo
BC074A009	Portagobo in Vetro
BC074A000	Lens Tube 19°
BC074A001	Lens Tube 26°
BC074A002	Lens Tube 36°
BC074A003	Lens Tube 50°
BC074A020	Profile Zoom 15°-30°

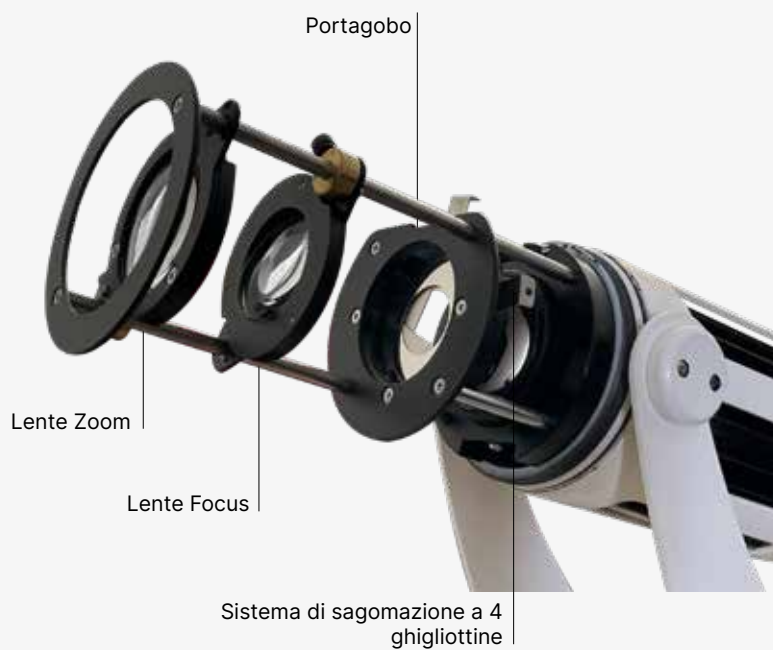

LEDko EXT M sistema di sagomazione a 4 ghigliottine

Tabelle DMX - Versione T/D

5 Canali

- 01 → Master Dimmer
- 02 → Canale Vuoto
- 03 → Dimmer Fine
- 04 → Strobo
- 05 → Funzioni Speciali

1 Canale

- 01 → Master Dimmer

Tabelle DMX - versione VariWhite

5 Canali

- 01 → Master Dimmer
- 02 → Dimmer Fine
- 03 → Tonalità di Bianco
- 04 → Effetto Strobo
- 05 → Funzioni Speciali

2 Canali

- 01 → Master Dimmer
- 02 → Tonalità di Bianco

1 Canale

- 01 → Master Dimmer

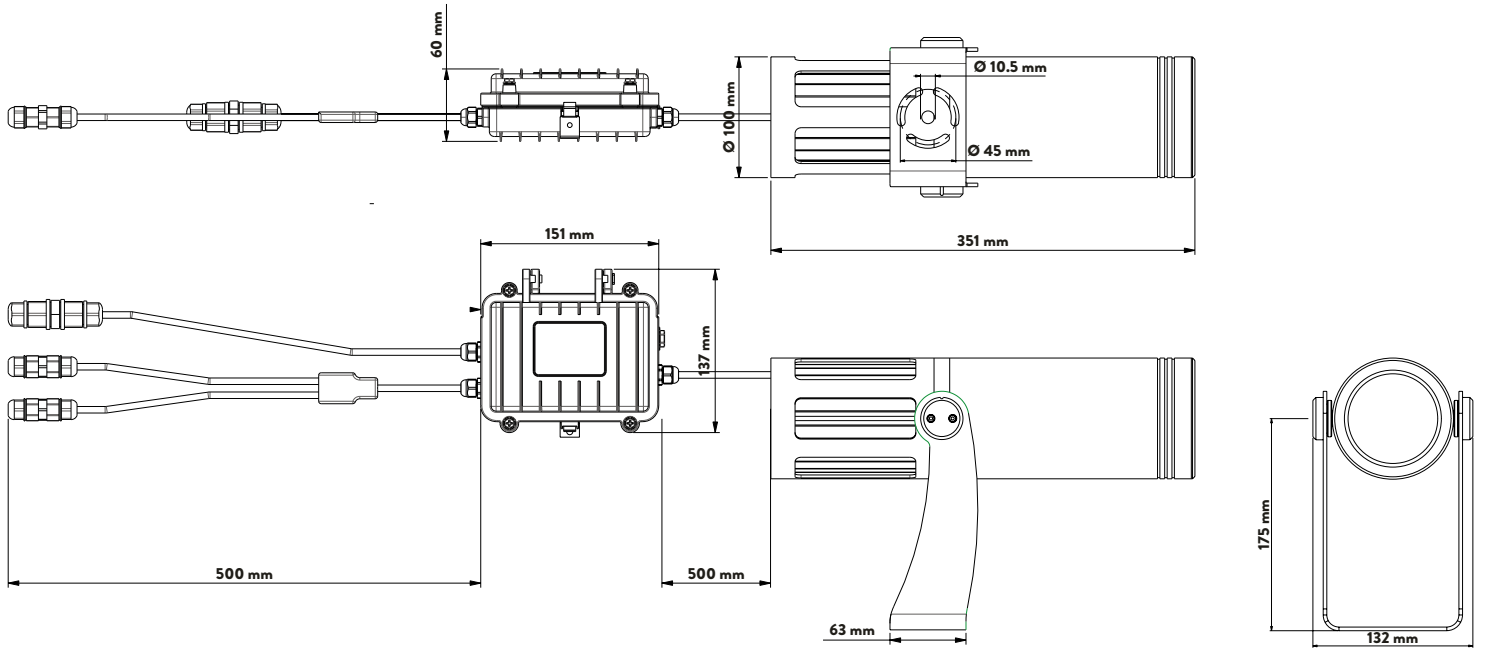

*Scatola di Alimentazione



Architetture da esterno - Residenza Six Senses, Crans-Montana, Svizzera

Prodotto	LEDko EXT M VW
CCT	2.800 K → 5.600 K
CRI	>95
Versione	Zoom 15-30°
Light Designer	Martin V. Cook
Intallazione	Etablissements Techniques Fragnière SA

LEDko M Profile Tungsten (3.000 K) - CRI 80

Ottica: **Lens Tube Profile 19°**

Distanza (m)	1	2	3	4	5	6	7	8	9	10
lux 3.000 K	18423	4606	2047	1151	737	512	376	288	227	184
Diametro Ø (m)	0.32	0.63	0.95	1.27	1.58	1.90	2.22	2.53	2.85	3.17

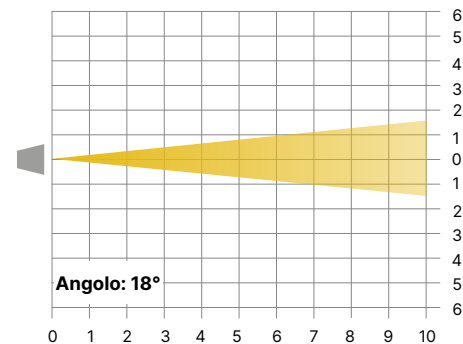

Ottica: **Lens Tube Profile 26°**

Distanza (m)	1	2	3	4	5	6	7	8	9	10
lux 3.000 K	9576	2394	1064	599	383	266	195	150	118	96
Diametro Ø (m)	0.46	0.92	1.39	1.85	2.31	2.77	3.23	3.96	4.16	4.62

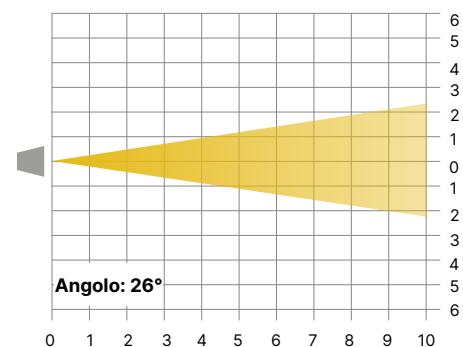

Ottica: **Lens Tube Profile 36°**

Distanza (m)	1	2	3	4	5	6	7	8	9	10
lux 3.000 K	6804	1701	756	425	272	189	139	106	84	68
Diametro Ø (m)	0.55	1.11	1.66	2.22	2.77	3.33	3.88	4.44	4.99	5.55

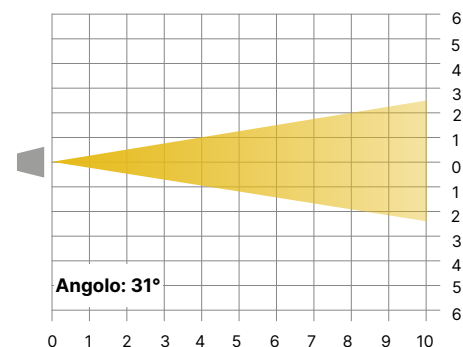

LEDko M Profile Tungsten (3.000 K) - CRI 80

Ottica: **Lens Tube Profile 50°**

Distanza (m)	1	2	3	4	5	6	7	8	9	10
lux 3.000 K	3240	810	360	203	130	90	66	51	40	32
Diametro Ø (m)	0.91	1.82	2.73	3.65	4.56	5.47	6.38	7.29	8.20	9.11

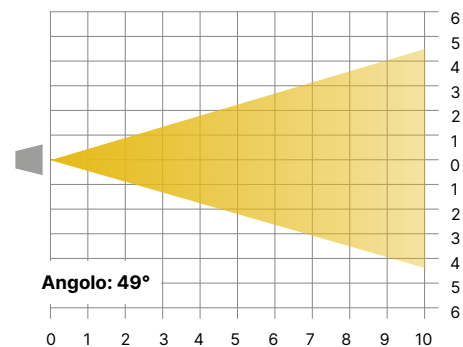

Ottica: **Profile Zoom 15° - 30° - SPOT**

Distanza (m)	1	2	3	4	5	6	7	8	9	10
lux 3.000 K	19440	4860	2160	1215	778	540	397	304	240	194
Diametro Ø (m)	0.25	0.49	0.74	0.98	1.23	1.47	1.72	1.96	2.21	2.46

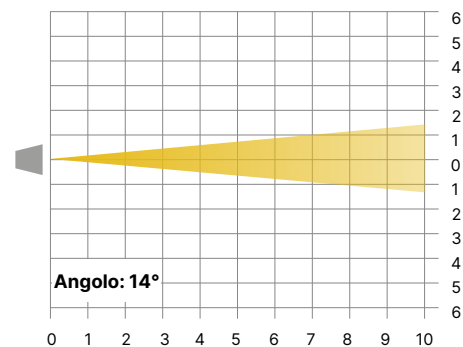

Ottica: **Profile Zoom 15° - 30° - FLOOD**

Distanza (m)	1	2	3	4	5	6	7	8	9	10
lux 3.000 K	9873	2468	1097	617	395	274	201	154	122	99
Diametro Ø (m)	0.48	0.96	1.44	1.92	2.40	2.88	3.36	3.84	4.32	4.80

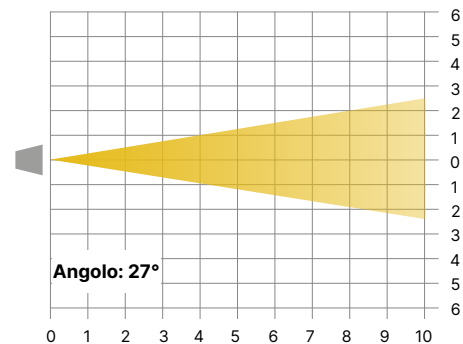

LEDko M Profile Daylight (5.000 K) - CRI 80

Ottica: **Lens Tube Profile 19°**

Distanza (m)	1	2	3	4	5	6	7	8	9	10
lux 5.000 K	20.268	5.067	2.252	1.267	811	563	414	317	250	203
Diametro Ø (m)	0.32	0.63	0.95	1.27	1.58	1.90	2.22	2.53	2.85	3.17

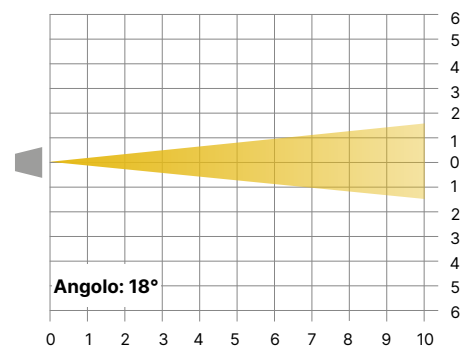

Ottica: **Lens Tube Profile 26°**

Distanza (m)	1	2	3	4	5	6	7	8	9	10
lux 5.000 K	10.530	2.633	1.170	658	421	293	215	165	130	105
Diametro Ø (m)	0.46	0.92	1.39	1.85	2.31	2.77	3.23	3.96	4.16	4.62

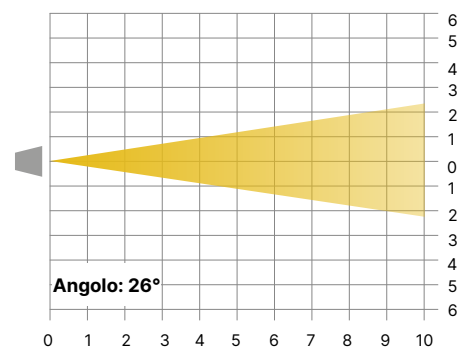

Optic: **Lens Tube Profile 36°**

Distanza (m)	1	2	3	4	5	6	7	8	9	10
lux 5.000 K	7.488	1.872	832	468	300	208	153	117	92	75
Diametro Ø (m)	0.55	1.11	1.66	2.22	2.77	3.33	3.88	4.44	4.99	5.55

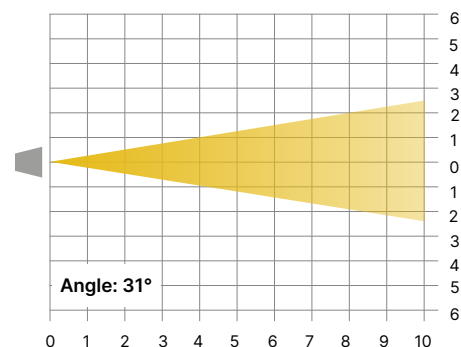

LEDko M Profile Daylight (5.000 K) - CRI 80

Ottica: **Lens Tube Profile 50°**

Distanza (m)	1	2	3	4	5	6	7	8	9	10
lux 5.000 K	3.356	891	396	223	143	99	73	56	44	36
Diametro Ø (m)	0.91	1.82	2.73	3.65	4.56	5.47	6.38	7.29	8.20	9.11

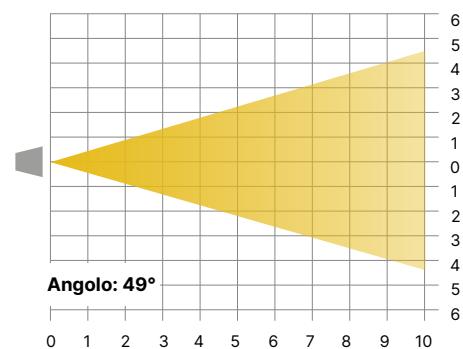

Ottica: **Profile Zoom 15° - 30° - SPOT**

Distanza (m)	1	2	3	4	5	6	7	8	9	10
lux 5.000 K	21.384	5.346	2.376	1.337	855	594	436	334	264	214
Diametro Ø (m)	0.25	0.49	0.74	0.98	1.23	1.47	1.72	1.96	2.21	2.46

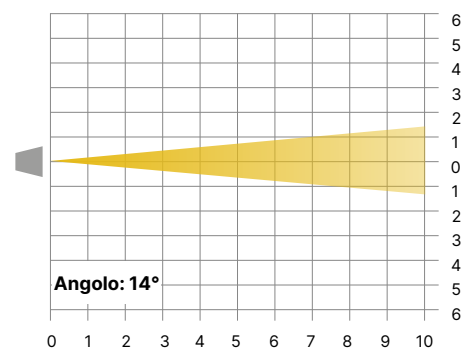

Ottica: **Profile Zoom 15° - 30° - FLOOD**

Distanza (m)	1	2	3	4	5	6	7	8	9	10
lux 5.000 K	10.863	2.716	1.207	679	435	302	222	170	134	109
Diametro Ø (m)	0.48	0.96	1.44	1.92	2.40	2.88	3.36	3.84	4.32	4.80

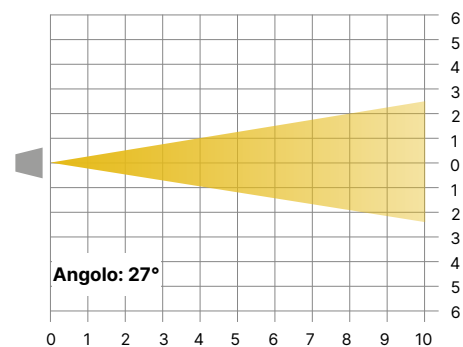

LEDko M Profile VariWhite - CRI > 95

Ottica: **Lens Tube Profile 19°**

Distanza (m)	1	2	3	4	5	6	7	8	9	10	
lux	3.200 K	13545	3386	1505	847	542	376	276	212	167	135
	5.600 K	17280	4320	1920	1080	691	480	353	270	213	173
Diametro Ø (m)	0.32	0.63	0.95	1.27	1.58	1.90	2.22	2.53	2.85	3.17	
3.200 K	CRI 97.2		TLCI 98								
5.600 K	CRI 95.4		TLCI 97.3								

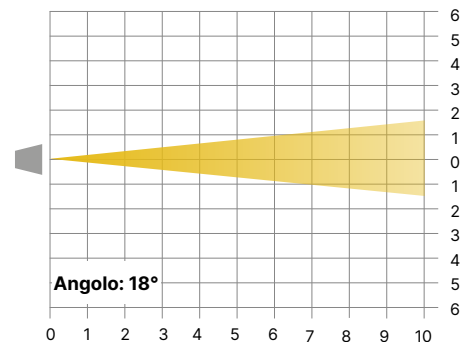

Ottica: **Lens Tube Profile 26°**

Distanza (m)	1	2	3	4	5	6	7	8	9	10	
lux	3.200 K	6876	1719	764	430	275	191	140	107	85	69
	5.600 K	8802	2201	978	550	352	245	180	138	109	88
Diametro Ø (m)	0.46	0.92	1.39	1.85	2.31	2.77	3.23	3.69	4.16	4.62	
3.200 K	CRI 97.2		TLCI 98								
5.600 K	CRI 95.5		TLCI 97.4								

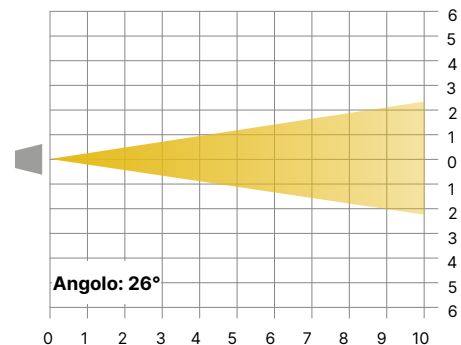

Ottica: **Lens Tube Profile 36°**

Distanza (m)	1	2	3	4	5	6	7	8	9	10	
lux	3.200 K	4599	1150	511	287	184	128	94	72	57	46
	5.600 K	5949	1487	661	372	238	165	121	93	73	59
Diametro Ø (m)	0.55	1.11	1.66	2.22	2.77	3.33	3.88	4.44	4.99	5.55	
3.200 K	CRI 97.3		TLCI 98								
5.600 K	CRI 95.2		TLCI 97.2								

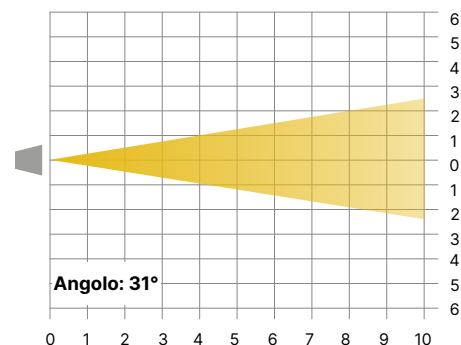

LEDko M Profile VariWhite - CRI > 95

Ottica: **Lens Tube Profile 50°**

Distanza (m)	1	2	3	4	5	6	7	8	9	10	
lux	3.200 K	2187	547	243	137	87	61	45	34	27	22
	5.600 K	3159	790	351	197	126	88	64	49	39	32
Diametro Ø (m)	0.91	1.82	2.73	3.65	4.56	5.47	6.38	7.29	8.20	9.11	
3.200 K	CRI 97.2		TLCI 98								
5.600 K	CRI 95		TLCI 97.3								

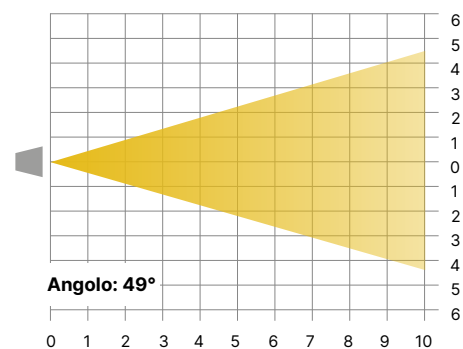

Ottica: **Profile Zoom 15° - 30° - SPOT**

Distanza (m)	1	2	3	4	5	6	7	8	9	10	
lux	3.200 K	15633	3908	1737	977	625	434	319	244	193	156
	5.600 K	22302	5576	2478	1394	892	620	455	348	275	223
Diametro Ø (m)	0.25	0.49	0.74	0.98	1.23	1.47	1.72	1.96	2.21	2.46	
3.200 K	CRI 97.4		TLCI 97.9								
5.600 K	CRI 93.6		TLCI 96.6								

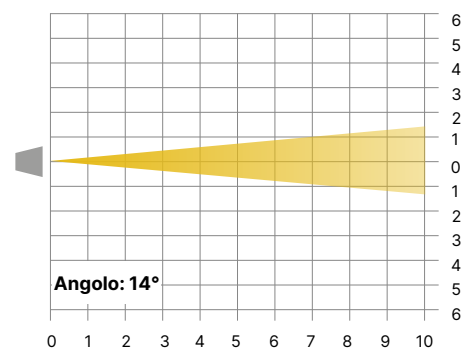

Ottica: **Profile Zoom 15° - 30° - FLOOD**

Distanza (m)	1	2	3	4	5	6	7	8	9	10	
lux	3.200 K	6543	1636	727	409	262	182	134	102	81	65
	5.600 K	8424	2106	936	527	337	234	172	132	104	84
Diametro Ø (m)	0.48	0.96	1.44	1.92	2.40	2.88	3.36	3.84	4.32	4.80	
3.200 K	CRI 97.3		TLCI 97.9								
5.600 K	CRI 95.2		TLCI 96.9								

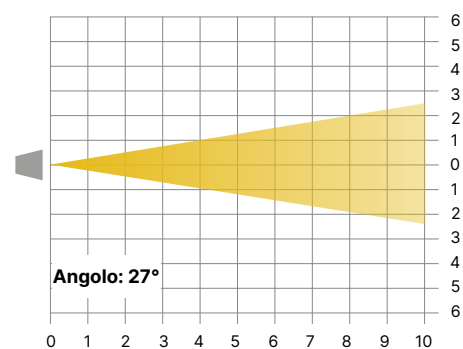

REPORT DEL TEST TM30

Rf 94,4

Fidelity index Rf

Rg 100,7

Gammut index Rg

■ Spectrum

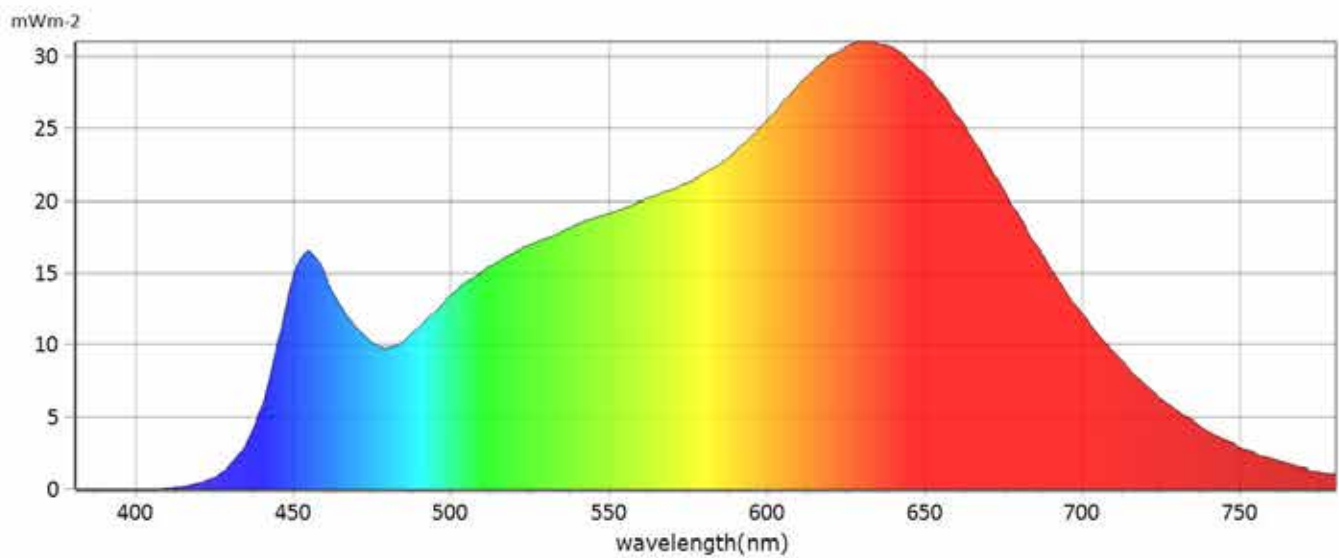

■ General Color Rendition

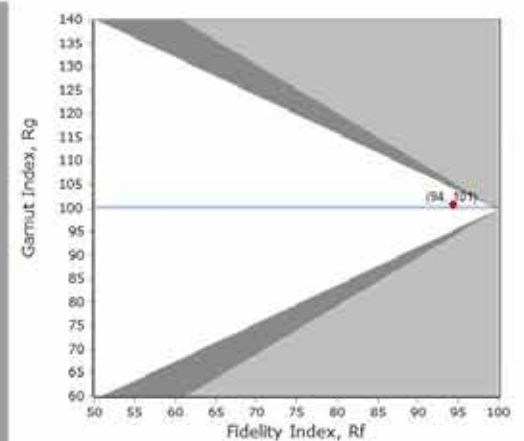
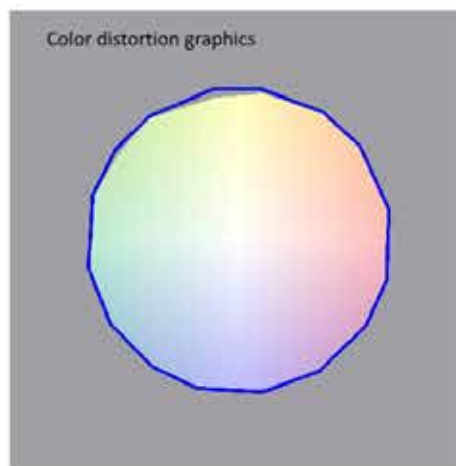
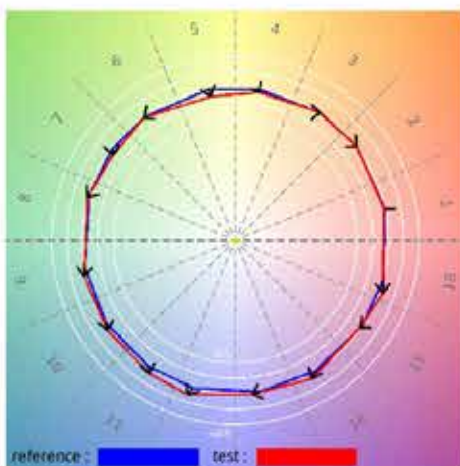

REPORT DEL TEST TM30

Rf 94,4

Fidelity index Rf

Rg 100,7

Gammut index Rg

Color Rendition by Hue

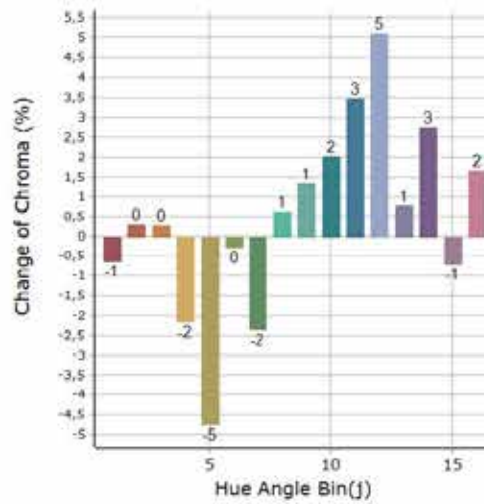
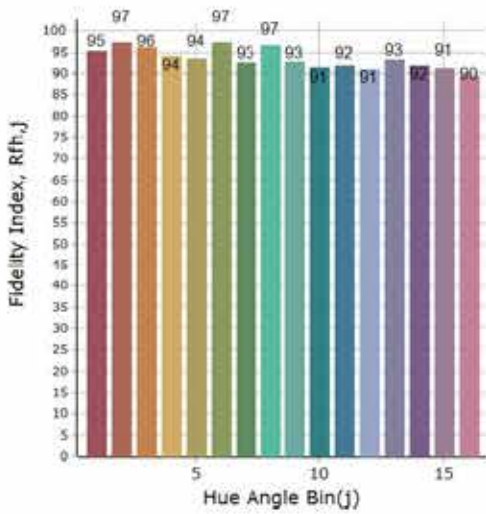

Hue Bin	Rf	Graphic shifts (%)	
		Chroma	Hue
1	95,3	-0,6%	0,9%
2	97,2	0,3%	-0,2%
3	96,0	0,3%	-0,4%
4	94,2	-2,2%	-2,2%
5	93,5	-4,7%	-0,7%
6	97,3	-0,3%	1,2%
7	92,5	-2,3%	3,4%
8	96,5	0,6%	1,9%
9	92,7	1,3%	5,1%
10	91,5	2,0%	4,2%
11	92,0	3,5%	3,6%
12	90,9	5,1%	-1,9%
13	93,2	0,8%	-4,5%
14	91,8	2,7%	-4,9%
15	91,2	-0,7%	-1,8%
16	89,6	1,7%	-8,3%

Color Fidelity by Sample

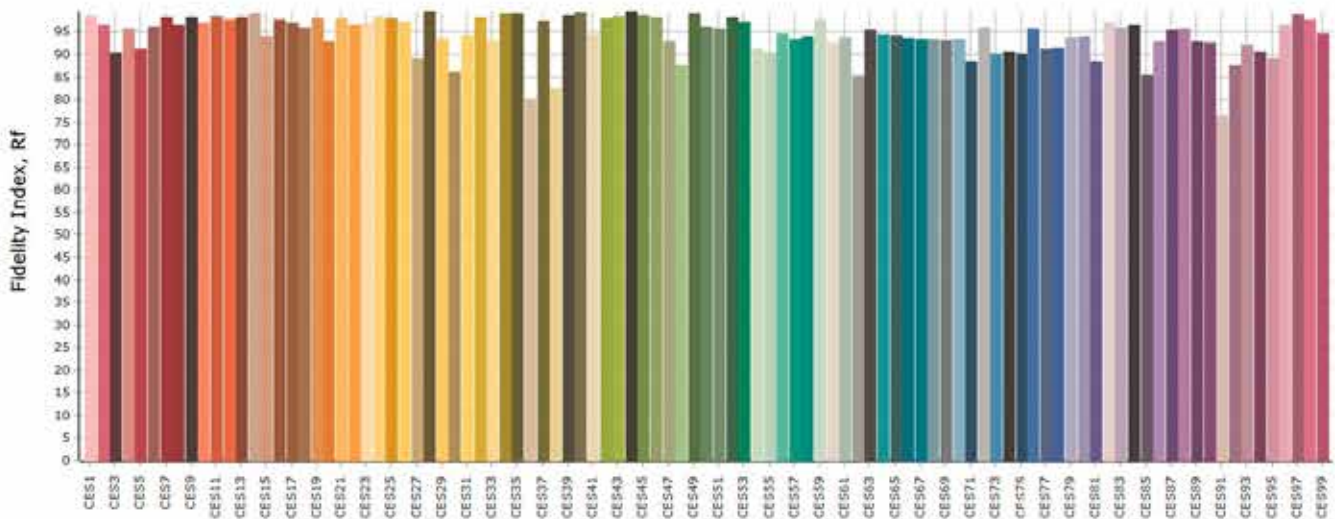

REPORT DEL TEST DELLO SPETTRO

BASE

CCT : 3164 K
 x : 0,4229
 y : 0,3936
 LambdaD : 583 nm
 LambdaP : 631 nm

Spectrum

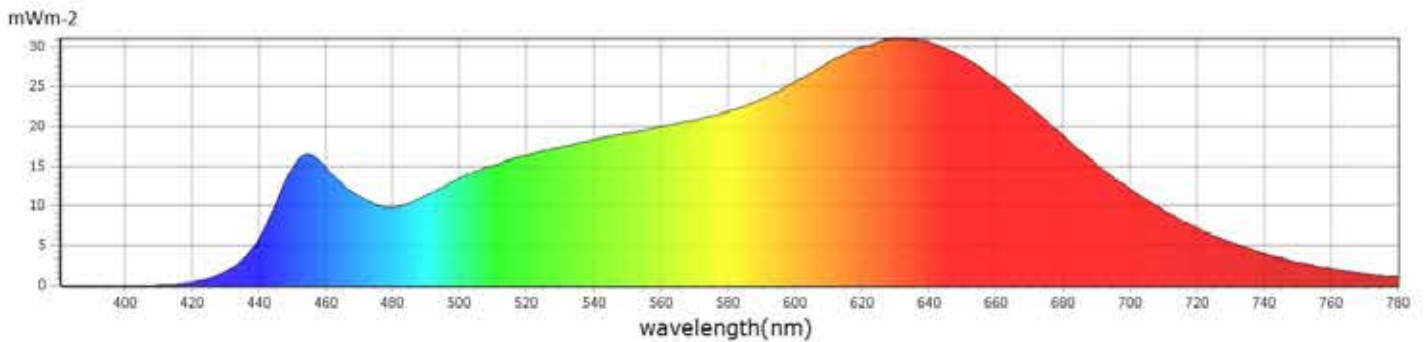

CIE1931

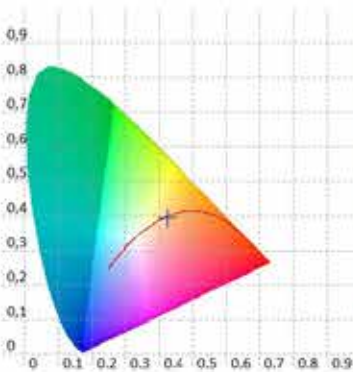

CIE1976

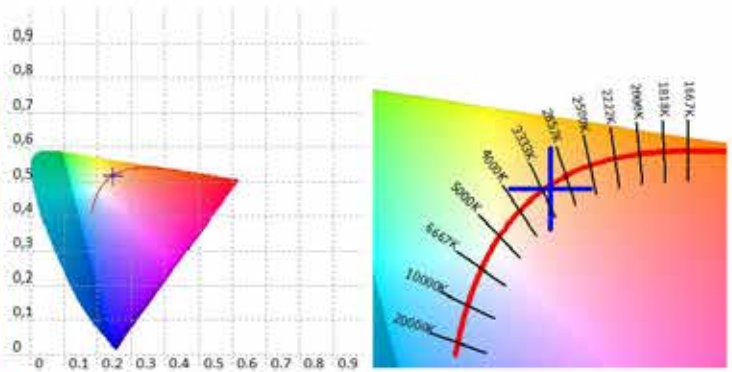

Features

CCT : 3164 K	x10 : 0,4270	delta-x : -0,0028	LambdaD : 583 nm	PPFD : 25,42 $\mu\text{mol}\cdot\text{m}^{-2}\cdot\text{s}^{-1}$	S/P : 1,58	R3 : 99,4	R10 : 95,9
LUX : 1505 lx	y10 : 0,3942	delta-y : -0,0063	LambdaP : 631 nm	PFD : 27,73 $\mu\text{mol}\cdot\text{m}^{-2}\cdot\text{s}^{-1}$	IRR : 5,586	R4 : 98,0	R11 : 95,3
I-Time : 8400 us	u'10 : 0,2484	delta-u' : 0,0008	Purity : 45,07%	PFD-B : 3,044 $\mu\text{mol}\cdot\text{m}^{-2}\cdot\text{s}^{-1}$	CQS : 96,2	R5 : 97,0	R12 : 86,0
x : 0,4229	v'10 : 0,5159	delta-v' : -0,0030	fc : 139,9	PFD-G : 8,963 $\mu\text{mol}\cdot\text{m}^{-2}\cdot\text{s}^{-1}$	CRI : 97,2	R6 : 94,6	R13 : 96,6
y : 0,3936	X : 1617,10	Duv : -0,0021	Rf : 94,4	PFD-R : 13,41 $\mu\text{mol}\cdot\text{m}^{-2}\cdot\text{s}^{-1}$	TLCI : 98,0	R7 : 96,8	R14 : 98,7
u' : 0,2459	Y : 1505,23	MEL : 954,9 lx	Rg : 100,7	PFD-UV : 0,0000 $\mu\text{mol}\cdot\text{m}^{-2}\cdot\text{s}^{-1}$	R1 : 97,1	R8 : 97,2	R15 : 97,9
v' : 0,5151	Z : 701,63	LambdaPV : 31,03	GAI : 65,4	PFD-FR : 2,309 $\mu\text{mol}\cdot\text{m}^{-2}\cdot\text{s}^{-1}$	R2 : 97,5	R9 : 95,9	

REPORT DEL TEST DELLO SPETTRO

BASE

CCT : 3164 K
 x : 0,4229
 y : 0,3936
 LambdaD : 583 nm
 LambdaP : 631 nm

CRI: 97,20

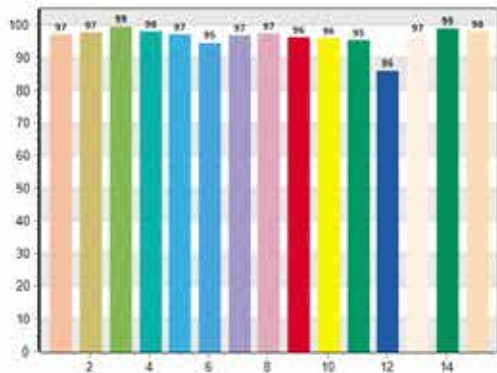

CQS: 96,24

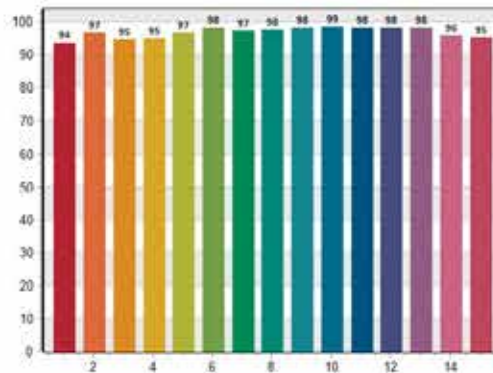

CRI-2

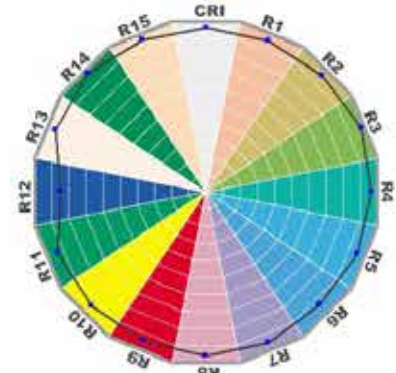

TM30: 94,36

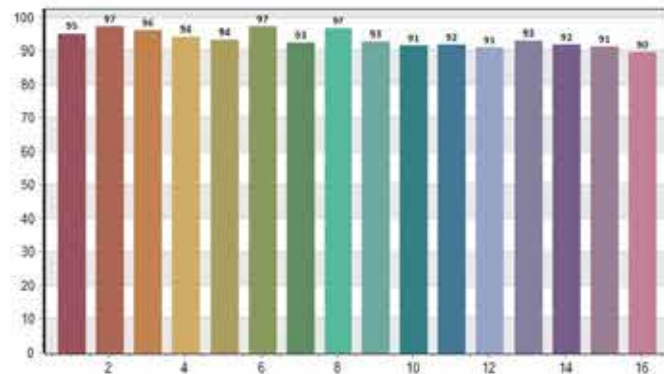

TLCI: 98,05

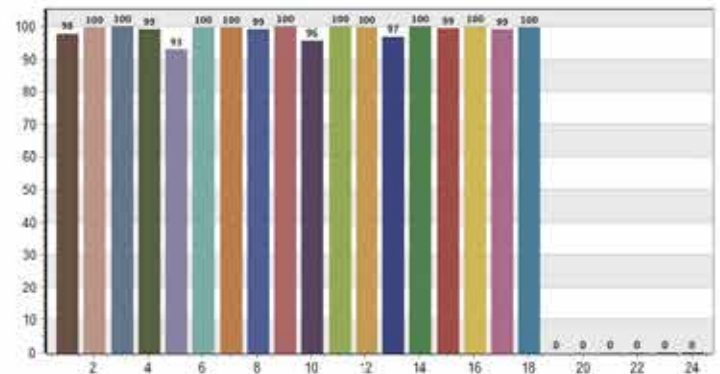

CRI values, only R1-R8 are used to calculate final CRI

R1	R2	R3	R4	R5	R6	R7	R8	R9	R10	R11	R12	R13	R14	R15
97,1	97,3	99,4	98,0	97,0	94,8	96,8	97,2	95,8	95,9	95,3	88,0	96,6	98,7	97,9

TM30 C values, 16 binned values out of total of 99 C values

C1	C2	C3	C4	C5	C6	C7	C8	C9	C10	C11	C12	C13	C14	C15	C16
95,3	97,2	96,0	94,2	93,5	97,3	92,5	96,5	92,7	91,5	92,0	90,9	93,2	91,8	91,2	89,6

CQS Q values

Q1	Q2	Q3	Q4	Q5	Q6	Q7	Q8	Q9	Q10	Q11	Q12	Q13	Q14	Q15
93,6	96,6	94,6	95,0	96,6	98,2	97,2	97,7	98,1	98,5	98,1	98,1	98,2	95,9	95,3

REPORT DEL TEST TM30

Rf 92,6

Fidelity index Rf

Rg 100,2

Gammut index Rg

■ Spectrum

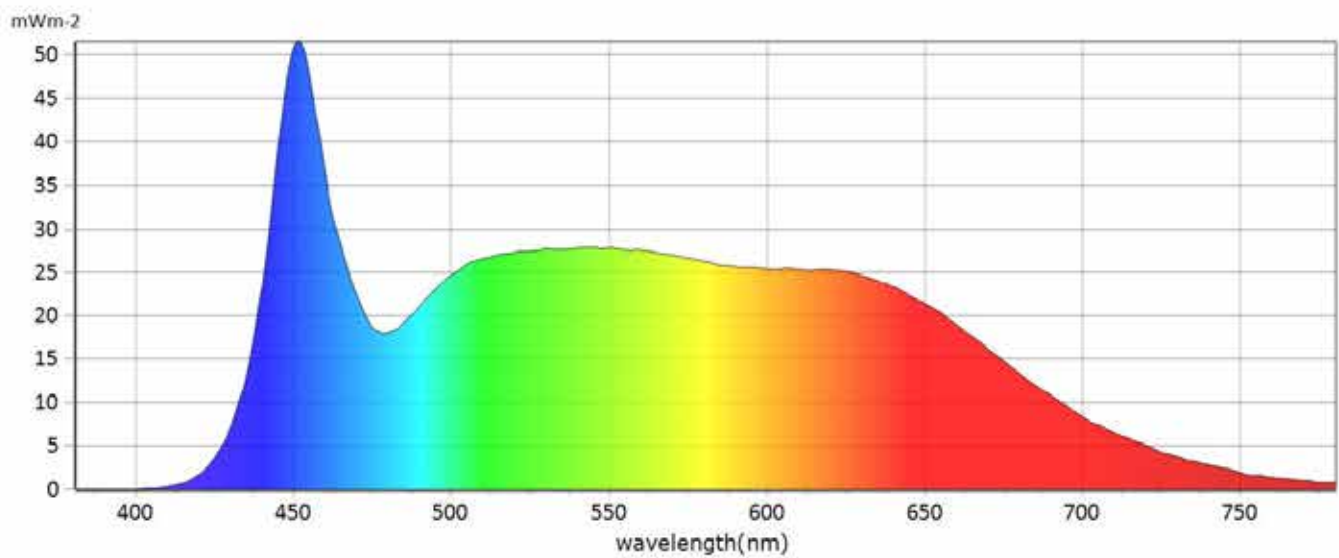

■ General Color Rendition

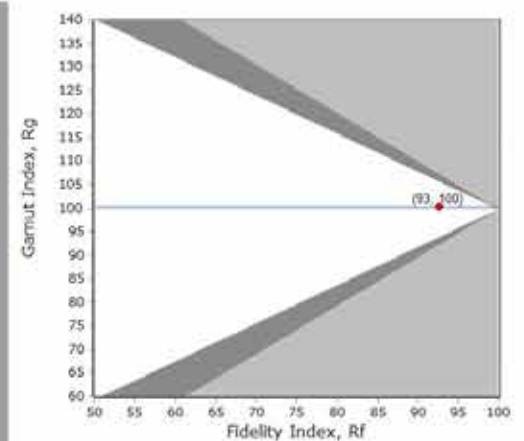
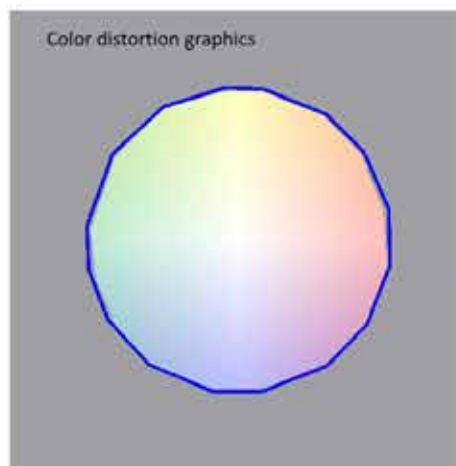
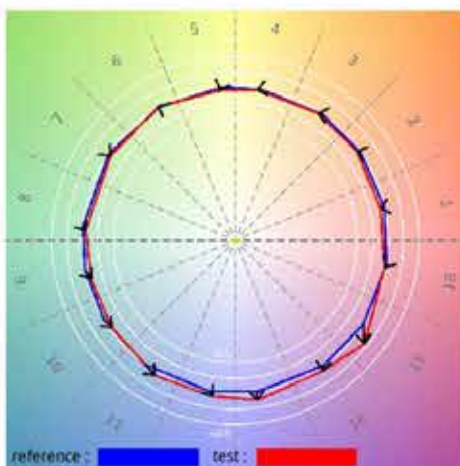

REPORT DEL TEST TM30

Rf 92,6

Fidelity index Rf

Rg 100,2

Gammut index Rg

Color Rendition by Hue

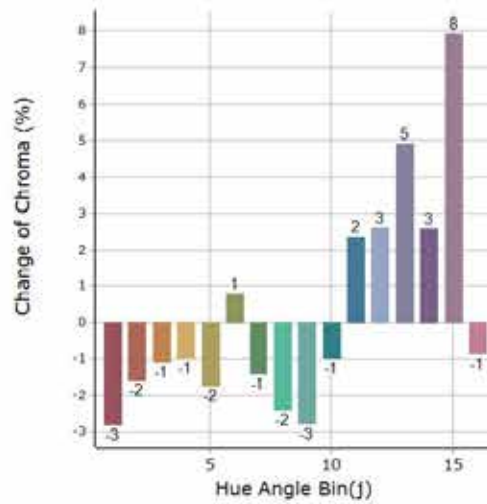
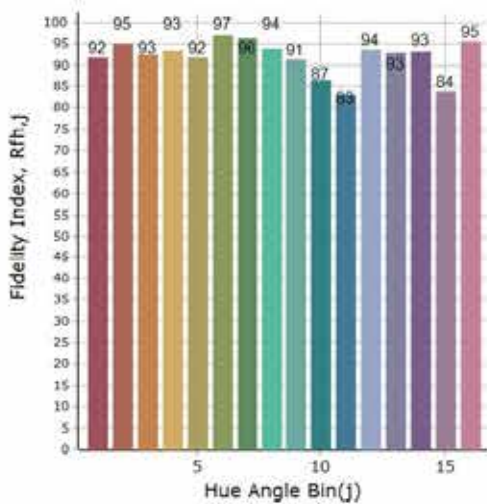

Hue Bin	Rf	Graphic shifts (%)	
		Chroma	Hue
1	91,9	-2,8%	-0,3%
2	95,1	-1,6%	1,6%
3	92,5	-1,1%	2,9%
4	93,4	-1,0%	1,5%
5	91,7	-1,7%	1,3%
6	96,9	0,8%	0,3%
7	96,3	-1,4%	0,3%
8	93,8	-2,4%	1,8%
9	91,3	-2,8%	6,4%
10	86,5	-1,0%	7,6%
11	83,1	2,4%	9,3%
12	93,7	2,6%	2,7%
13	93,0	4,9%	-0,6%
14	93,2	2,6%	-2,2%
15	83,9	7,9%	-10,3%
16	95,5	-0,9%	-1,9%

Color Fidelity by Sample

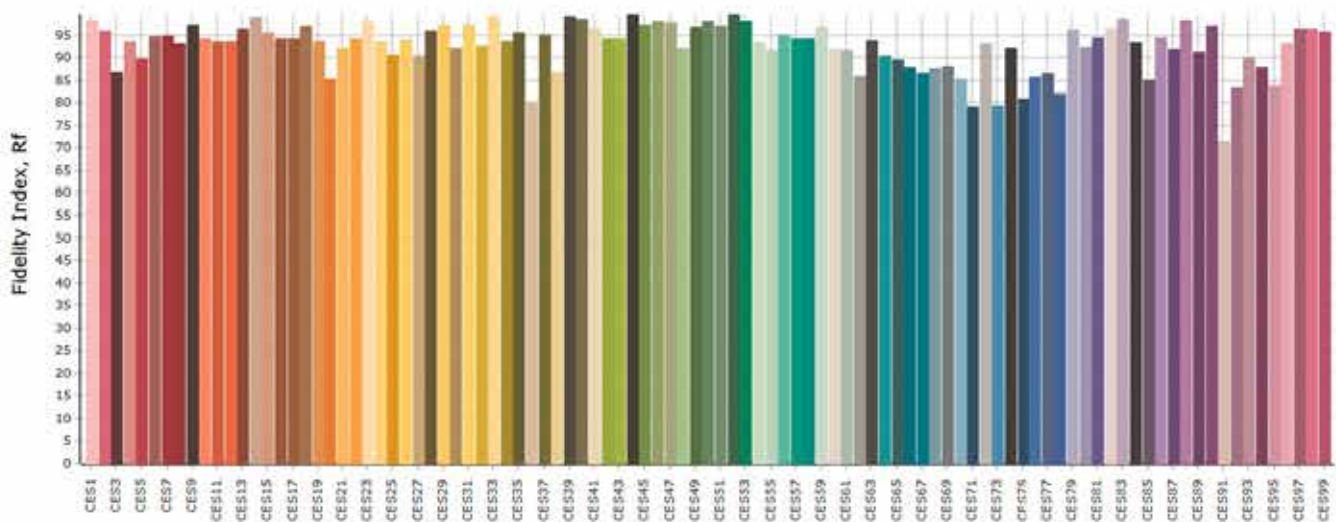

● Coemar Lighting S.r.l.

Via Carpenedolo, 90
46043, Castiglione delle Stiviere (MN) – Italy

P. +39 0376 1514412

M1. info@coemar.com

M2. service@coemar.com

W. coemar.com

P.iva – C.f. 02415330204

