

ReLite Led Kit HD +

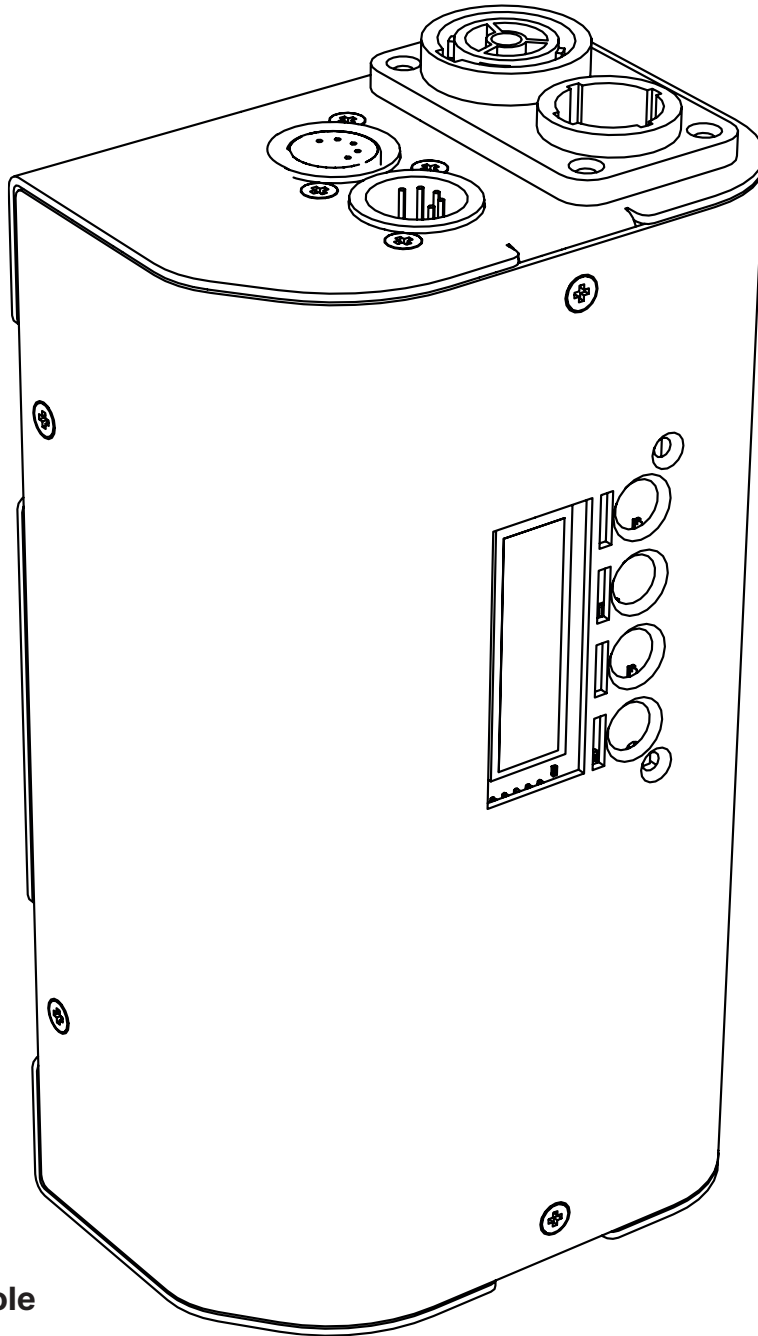

*The image is for the sole
purpose of presenting
the product

USER MANUAL

vrs. 1.6 - 14.01.2025



 **coemar**

© 2023 Coemar Lighting Srl. All rights reserved.

Information subject to change without notice. Coemar and all affiliated companies disclaim liability for any injury, damage, direct or indirect loss, consequential or economic loss or any other loss occasioned by the use of, inability to use or reliance on the information contained in this document. The Coemar logo, the Coemar name and all other trade-marks in this document pertaining to services or products by Coemar or its affiliates and subsidiaries are trademarks or licensed by Coemar or its affiliates or subsidiaries.

No part of this document may be used for distribution, reproduction, transmission, transcription, storage in a data retrieval system, or translated into any language in any form by any means without the prior written permission of Coemar ®. If you are downloading files from our web pages for your personal use, make sure to check for updated versions. Coemar ® cannot take any liability whatsoever for downloaded files, as technical data are subject to change without notice.

Congratulations on having purchased a **Coemar** product. You have assured yourself of a fixture of the highest quality, both in componentry and in the technology used. We renew our invitation to you to complete the service information on the previous page, to expedite any request for service information or spares (in case of problems encountered either during, or subsequent to, installation). This information will assist in providing prompt and accurate advice from your **Coemar** service centre. Following the instructions and procedures outlined in this manual will ensure the maximum efficiency of this product for years to come.

Index

1. Packaging and transportation

1.1 Packaging

Open the packaging and make sure that no part of the equipment has suffered any damage during the transportation. In case of damage to the fixture, contact your carrier and your supplier immediately by telephone, fax or email, and inform them you will formally notify them in writing through registered letter.

Packing list

Make sure the packaging contains:

1 ReLite Box

1 ReLite Led Group

1 True1 Top connector

1 Instruction manual

1.2 Transportation

The **ReLite Led Kit HD +** must be transported exclusively in its original packaging.

2. General information

2.1 Important Safety information

Fire prevention:



1. Never locate the fixture on any flammable surface.
2. Minimum distance from flammable materials: 0,5 m.
3. Minimum distance from the closet illuminable surface: 0,5 m.
4. Replace any blown or damaged fuse only with those of identical values.
Refer to the schematic diagram if there is any doubt.
5. Connect the projector, where the **ReLite Led Kit HD +** is installed, to mains power protected by a thermal magnetic circuit breaker.

Prevention from electric shock:



1. Presence of high voltage inside of the fixture. Insulate the fixture from mains supply before opening or performing any function which involves touching the inside of the fixture, including lamp replacement.
2. For the connection to the mains, adhere strictly to the guidelines outlined in this manual.

3. The level of technology of **ReLite Led Kit HD +** requires the use of specialised personnel for all service applications; refer all work to your authorised **Coemar** service centre.
4. A good earth connection is essential for the proper functioning of the projector. Never connect the fixture if there is no earth connection.
5. Mains cables must not come into contact with other cables.
6. Do not operate the projector with wet hands or in an area where water is present.
7. The fixture must never be located in an exposed position, or in areas of extreme humidity.

Safety:



1. The external surfaces of the unit, at various points, may reach 60°C. Never handle the unit until at least 10 minutes have elapsed since the LED was turned off.
2. Never install the fixture in an enclosed area lacking sufficient air flow; the room temperature must not exceed 40°C.
3. The projector contains electronic and electrical components which must under no circumstances be in contact with water, oil or any other liquid. Failure to do so will compromise the proper functioning of the projector.

2.2 Warranty conditions

1. The fixture is under warranty for 24 months from the purchase date against factory defec-tions.
2. Damage ought to unskillfulness, inappropriate use, or lack of suggested maintenance are excluded from the warranty.
3. Warranty expires when the projector is opened by unauthorized personnel.
4. Warranty doesn't include the replacement of the fixture.
5. Serial number and model of the fixture are necessary to retrieve informations and assistance from the dealer.

2.3 EC Norms

1. The fixture satisfies the essential requirements of the directive 2004/108/EC, 2006/95/EC, 2011/65/EC, 2002/96/EC & 2003/108/EC.
2. The fixture is in accordance with the standard EN 50419 (RoHS) and satisfies the require-ments of the directive 2002/96/EC (WEEE).

3. Product specifications

3.1 Technical characteristics

Power supply	80-264 V, auto-sensing, 50-60 Hz
Maximum current	Depending on the LED module and the size/model of the fixture
Power factor	$\text{Cos}\phi > 0.95$
Power consumption	Depending on the LED module and the size/model of the fixture
Color temperature	Proportional control 2.700 → 6.500 K (VariWhite version) 3.200 K (Tungsten) or 5.600 K (Daylight)
Weight (Box)	1.5 Kg / 3.3 lbs. (S version) 2.5 Kg / 5.5 lbs (M/L version)
Operating Ta (°C/F) range	-0 to 40°C (32 to 104° F), two thermal protection at 95°C/203°F (LED) and 85°/185°F (Board)
Connectors	G22 - GX9.5 - G38 - GY9.5 - GY16 - Custom
IP rating	20

3.2 Dimensions

ReLite Led Kit HD + S

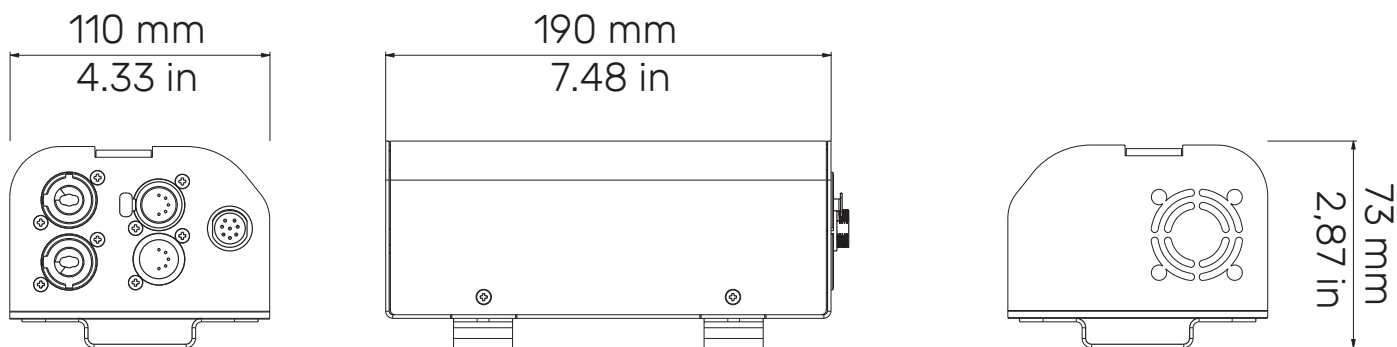

ReLite Led Kit HD + M/L

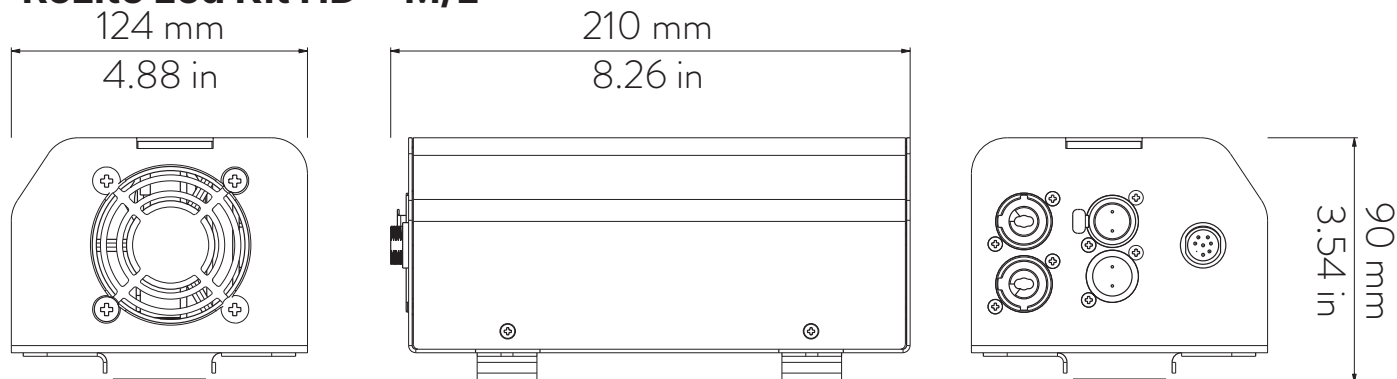

3.3 Unit's main components

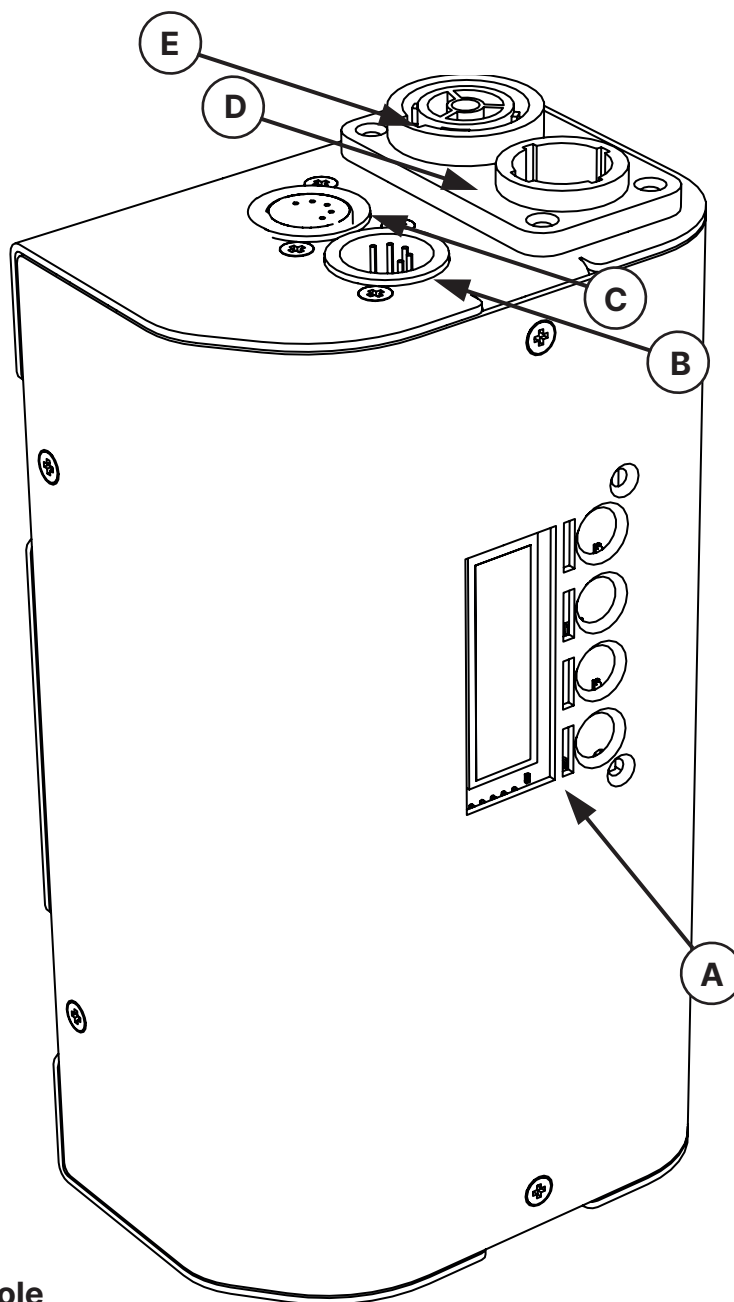

*The image is for the sole purpose of presenting the product

**The LED group depends on the size/model of the fixture

Components description

A	Display panel
B	DMX In
C	DMX Out
D	PowerCon TRUE1 Top In
E	PowerCon TRUE1 Top Out

4. Installation

4.1 Mechanical installation

With **ReLite Led Kit HD +** will be possible to give new life to your projector, simply replacing the old lamp with the **ReLite Led Group**.

The **ReLite Box** can be fixed at the projector's yoke through the fixing plates present on the box (**A**).

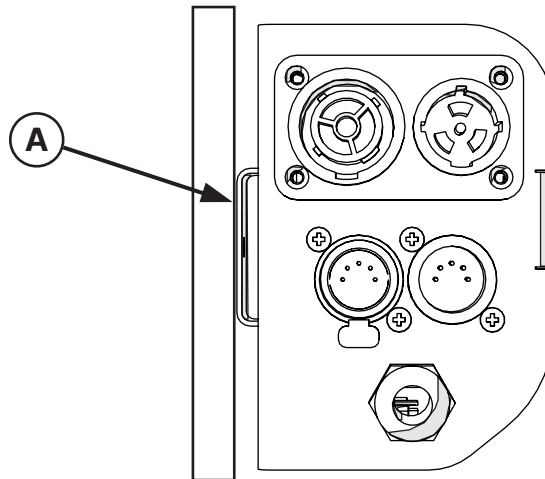

Warning!!

Always ensure that your support structure and fixing (bolts, clamps, etc...) are rated to support the weight of the fixture.

5. Powering up

5.1 Operating voltage and frequency

The unit may operate at voltage ranges from 80 to 264 V at a frequency of 50 or 60 Hz. It is not needed to effect any setup procedures: **ReLite Led Kit HD +** will automatically adjust its operation to suit any frequency or voltage within this range.

5.2 Connection to mains power

Connection to mains power

ReLite Led Kit HD + equipped with two power connectors, one as input and one as output, which can be used to feed up to 8 (at 230 V) or 4 (115 V) fixtures.

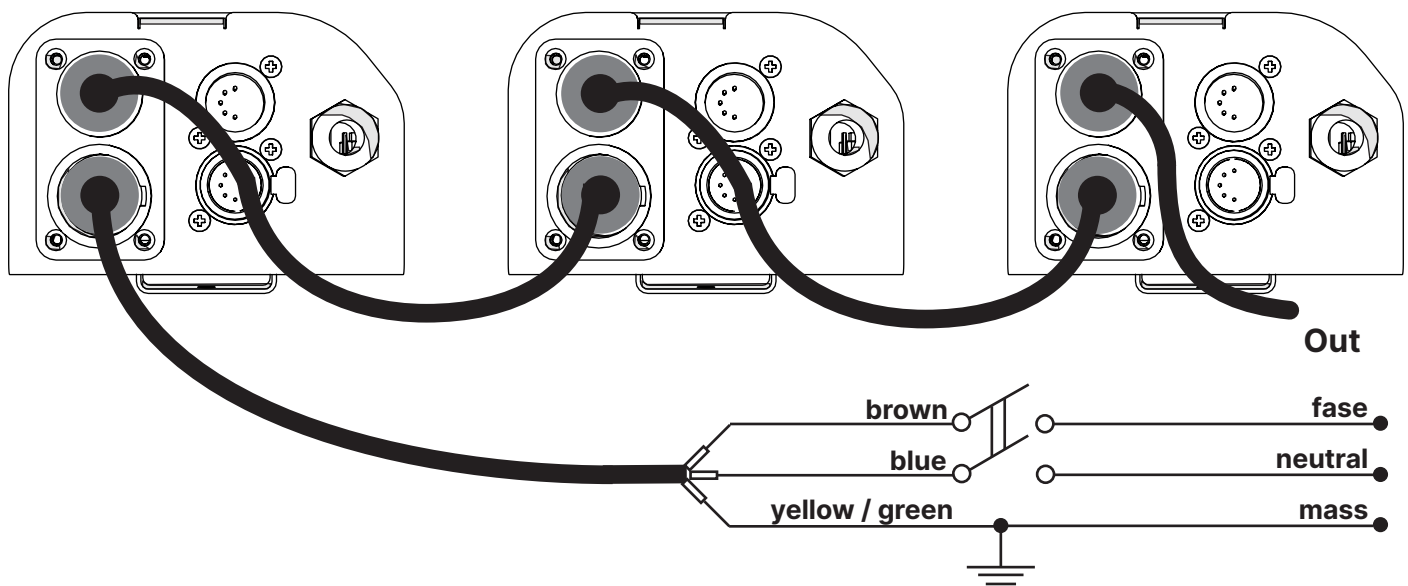

Warning!!

The use of a thermal/magnetic circuit breaker is recommended. Strict adherence to regulatory norms is strongly recommended.

Ensure that the mains characteristics are within the recommended range for the use of **ReLite Led Kit HD +**.

All connections should be carried out by a suitably qualified personnel.

6. Control signal connections

6.1 Control signal connection by XLR5 plugs

The digital control signal is transmitted to the projector via a two pole cable screened in according to the International standards for DMX 512 data transmission. The connection must be serial, using connectors XLR5 male and female located on the back of **ReLite Led Kit HD +** labelled DMX512 IN e OUT.

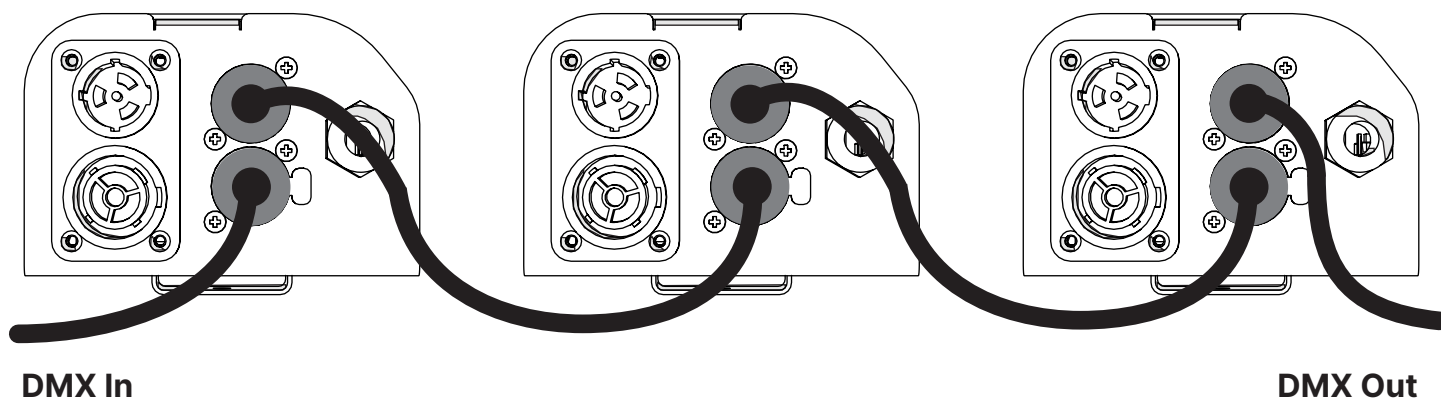

Warning!

Make sure that screening and conductors are not in contact one another or with the metal housing of the connector.

Pin#1 and housing must never be connected to the power supply unit.

6.2 Power Unit

The **ReLite Led Kit HD +** can be also used with a power unit that allows an absolute dimming control for your fixture.

7. Turning the ReLite Led Kit HD + on

After having followed the preceding steps described, proceed with the power supply and turn on the projector connecting it to the mains power.

The software version installed on the internal microprocessors will be shown on the display, suddenly it will show the current DMX addressing. If the address blinks, it means that the DMX signal has not been received. Check the connection cable and the mixer functioning.

7.1 DMX address of the unit

Each projector can use **5, 2, 1, SUNRISE, RAW** (VariWhite version) and **5, 1** (T/D versions) address channels for its complete operation and is controlled by a DMX 512 signal.

DMX addressing



When powered up initially, each projector will show "A001", which indicates that the fixture will start responding from the first DMX channel; **ReLite Led Kit HD +** also uses 5 DMX channels, which means that it will respond to the commands from channel 1 to channel 5 of your DMX 512 controller. Accordingly a second unit should be addressed as A006, a third one as A011 and so on. The operation must be carried out on every **ReLite Led Kit HD +** which has an address different from A001.

Altering the DMX address:

1. Press the + or – button until the display shows the required DMX address. The digits on the display will blink to indicate that the variation has not been registered.
2. Press the enter key to confirm your selection. The digits on the display panel will cease to blink and the projector will now respond to the new address.

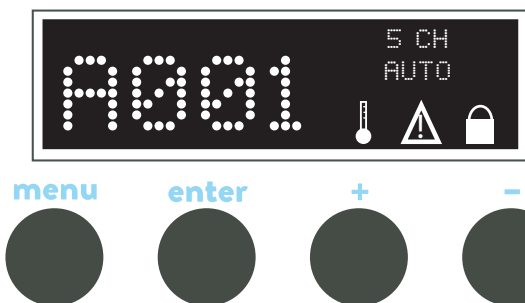
Note: by holding the + or – button down the scrolling will be faster; thus allowing a faster selection



-  It means the projector has entered protection
-  It means there is an error, it flashes intermittently with address
-  The keys are locked

Warning!!

If you alter the DMX address with no DMX signal connected, the digits on the display panel will continue to flash even after you have pressed ENTER button to confirm the address.

8. DMX chart Fixed White Version

8.1 DMX Chart 5 and 1 channels

channel		function	type of control	effect	decimal		percentage	
5	1							
1	1	master dimmer	proportional	adjust luminous output intensity from 0 to 100%	0	- 255	0%	- 100%
2	-	spare channel	step	no effect	0	- 255	0%	- 100%
3	-	dimmer fine	proportional	fine dimmer control 16 bit	0	- 255	0%	- 100%
4	-	strobe	step	no effect	0	- 9	0%	- 4%
			proportional	variable speed strobing effect, from slow to fast	10	- 57	4%	- 22%
			step	stop strobe	58	- 59	23%	- 23%
			proportional	sequenced pulse effect, slow closing, fast opening (variable speed pulsing, from slow to fast)	60	- 108	24%	- 42%
			step	stop strobe	109	- 110	43%	- 43%
			proportional	sequenced pulse effect, fast closing, slow opening (variable speed pulsing, from slow to fast)	111	- 159	44%	- 62%
			step	stop strobe	160	- 161	63%	- 63%
			proportional	random strobe effect with variable speed from slow to fast	162	- 207	64%	- 81%
			step	stop strobe	208	- 209	82%	- 82%
			proportional	random strobe effect with variable speed from slow to fast	210	- 255	82%	- 100%
5	-	special functions	step	park	0	- 9	0%	- 4%
				no effect	10	- 84	4%	- 33%
				fan at low-noise mode	85	- 96	33%	- 38%
				fan at studio mode	97	- 108	38%	- 42%
				fan at auto-silent mode	109	- 120	43%	- 47%
			proportional	fan speed control mode	121	- 133	47%	- 52%
			step	enables the automatic display blackout	134	- 185	53%	- 73%
				disables the automatic display blackout	186	- 199	73%	- 78%
				no effect	200	- 255	78%	- 100%

9. DMX chart VariWhite Version

9.1 DMX Chart 5 channels

channel	function	type of control	effect	decimal		percentage	
				min	max	min	max
1	master dimmer	proportional	adjust luminous output intensity from 0 to 100%	0	255	0%	100%
2	dimmer fine	proportional	fine dimmer control 16 bit	0	255	0%	100%
3	white tone	step	2.700 K	0	6	0%	2%
		proportional	proportional value from 2.700 K to 3.200 K	7	33	3%	13%
		step	3.200 K	34	60	13%	24%
		proportional	proportional value from 3.200 K to 4.000 K	61	87	24%	34%
		step	4.000 K	88	114	35%	45%
		proportional	proportional value from 4.000 K to 5.000 K	115	141	45%	55%
		step	5.000 K	142	168	56%	66%
		proportional	proportional value from 5.000 K to 5.600 K	169	195	66%	76%
		step	5.600 K	196	222	77%	87%
		proportional	proportional value from 5.600 K to 6.500 K	223	249	87%	98%
		step	6.500 K	250	255	98%	100%
4	strobe	step	no effect	0	9	0%	4%
		proportional	variable speed strobing effect, from slow to fast	10	57	4%	22%
		step	stop strobe	58	59	23%	23%
		proportional	sequenced pulse effect, slow closing, fast opening (variable speed pulsing, from slow to fast)	60	108	24%	42%
		step	stop strobe	109	110	43%	43%
		proportional	sequenced pulse effect, fast closing, slow opening (variable speed pulsing, from slow to fast)	111	159	44%	62%
		step	stop strobe	160	161	63%	63%
		proportional	random strobe effect with variable speed from slow to fast	162	207	64%	81%
		step	stop strobe	208	209	82%	82%
		proportional	random strobe effect with variable speed from slow to fast	210	255	82%	100%
5	special functions	step	park	0	9	0%	4%
			no effect	10	84	4%	33%
			fan at low-noise mode	85	96	33%	38%
			fan at studio mode	97	108	38%	42%
			fan at auto-silent mode	109	120	43%	47%
		proportional	fan speed control mode	121	133	47%	52%
		step	enables the automatic display blackout	134	185	53%	73%
			disables the automatic display blackout	186	199	73%	78%
no effect	200		255	78%	100%		

9.2 DMX Chart 2/1 channels

channel		function	type of control	effect	decimal		percentage	
2	1							
1	1	master dimmer	proportional	adjust luminous output intensity from 0 to 100%	0	- 255	0%	- 100%
2	-	white tone	proportional	proportional value from 2.700 K to 6.500 K	0	- 255	0%	- 100%

9.3 DMX Chart Sunrise mode

channel	function	type of control	effect	decimal	percentage
1	master dimmer	proportional	adjust luminous output intensity from 0 to 100%	0 - 255	0% - 100%
2	dimmer fine	proportional	fine dimmer control 16 bit	0 - 255	0% - 100%
3	proportional cct	proportional	2.700 K	0	0%
			proportional value from 2.700 K to 4000 K	1 - 86	0% - 34%
			4.000 K	87	34%
			proportional value from 4.000 to 5.000 K	88 - 152	35% - 60%
			5.000 K	153	60%
			proportional value from 5.000 to 5.600 K	154 - 192	60% - 75%
			5.600 K	193	76%
			proportional value from 5.600 K to 6.500 K	194 - 254	76% - 100%
4	step cct	step	6.500 K	255	100%
			no effect	0 - 9	0% - 4%
			2.700 K	10 - 50	4% - 20%
			3.200 K	51 - 91	20% - 36%
			4.000 K	92 - 132	36% - 52%
			5.000 K	133 - 173	52% - 68%
			5.600 K	174 - 213	68% - 84%
5	special functions	step	park	0 - 9	0% - 4%
			no effect	10 - 84	4% - 33%
			fan at low-noise mode	85 - 96	33% - 38%
			fan at studio mode	97 - 108	38% - 42%
		proportional	fan at auto-silent mode	109 - 120	43% - 47%
			fan speed control mode	121 - 133	47% - 52%
		step	enables the automatic display blackout	134 - 185	53% - 73%
			disables the automatic display blackout	186 - 199	73% - 78%
			no effect	200 - 255	78% - 100%

Note 1: If channels 3 and 4 are used simultaneously, channel 4 prevails.

9.4 DMX Chart Raw mode

channel	function	type of control	effect	decimal		percentage	
1	warm white led	proportional	adjust luminous output intensity of warm white led from 0 to 100%	0	- 255	0%	- 100%
2	warm white led fine	proportional	warm white led fine control 16 bit	0	- 255	0%	- 100%
3	cold white led	proportional	adjust luminous output intensity of cold white led from 0 to 100%	0	- 255	0%	- 100%
4	cold white led fine	proportional	cold white led fine control 16 bit	0	- 255	0%	- 100%

9.5 DMX Chart 2 channels (MK1)

channel	function	type of control	effect	decimal	percentage
1	master dimmer	proportional	adjust luminous output intensity from 0 to 100%	0 - 255	0% - 100%
2	white tone	step	3200 K	0 - 10	0% - 4%
			2700 K	11 - 16	4% - 6%
			2800 K	17 - 22	7% - 9%
			2900 K	23 - 28	9% - 11%
			3000 K	29 - 34	11% - 13%
			3100 K	35 - 40	14% - 16%
			3200 K	41 - 46	16% - 18%
			3300 K	47 - 52	18% - 20%
			3400 K	53 - 58	21% - 23%
			3500 K	59 - 64	23% - 25%
			3600 K	65 - 70	25% - 27%
			3700 K	71 - 76	28% - 30%
			3800 K	77 - 82	30% - 32%
			3900 K	83 - 88	33% - 35%
			4000 K	89 - 94	35% - 37%
			4100 K	95 - 100	37% - 39%
			4200 K	101 - 106	40% - 42%
			4300 K	107 - 112	42% - 44%
			4400 K	113 - 118	44% - 46%
			4500 K	119 - 124	47% - 49%
			4600 K	125 - 130	49% - 51%
			4700 K	131 - 136	51% - 53%
			4800 K	137 - 142	54% - 56%
			4900 K	143 - 148	56% - 58%
			5000 K	149 - 154	58% - 60%
			5100 K	155 - 160	61% - 63%
			5200 K	161 - 166	63% - 65%
			5300 K	167 - 172	65% - 67%
5400 K	173 - 178	68% - 70%			
5500 K	179 - 184	70% - 72%			
5600 K	185 - 190	73% - 75%			
5700 K	191 - 196	75% - 77%			
5800 K	197 - 202	77% - 79%			
5900 K	203 - 208	80% - 82%			
6000 K	209 - 214	82% - 84%			
6100 K	215 - 220	84% - 86%			
6200 K	221 - 226	87% - 89%			
6300 K	227 - 232	89% - 91%			
6400 K	233 - 238	91% - 93%			
6500 K	239 - 244	94% - 96%			
5600 K	245 - 255	96% - 100%			

9.6 DMX Chart 6 channels

channel	function	type of control	effect	decimal	percentage
1	master dimmer	proportional	adjust luminous output intensity from 0 to 100%	0 - 255	0% - 100%
2	dimmer fine	proportional	fine dimmer control 16 bit	0 - 255	0% - 100%
3	white tone	step	3200 K	0 - 10	0% - 4%
			2700 K	11 - 16	4% - 6%
			2800 K	17 - 22	7% - 9%
			2900 K	23 - 28	9% - 11%
			3000 K	29 - 34	11% - 13%
			3100 K	35 - 40	14% - 16%
			3200 K	41 - 46	16% - 18%
			3300 K	47 - 52	18% - 20%
			3400 K	53 - 58	21% - 23%
			3500 K	59 - 64	23% - 25%
			3600 K	65 - 70	25% - 27%
			3700 K	71 - 76	28% - 30%
			3800 K	77 - 82	30% - 32%
			3900 K	83 - 88	33% - 35%
			4000 K	89 - 94	35% - 37%
			4100 K	95 - 100	37% - 39%
			4200 K	101 - 106	40% - 42%
			4300 K	107 - 112	42% - 44%
			4400 K	113 - 118	44% - 46%
			4500 K	119 - 124	47% - 49%
			4600 K	125 - 130	49% - 51%
			4700 K	131 - 136	51% - 53%
			4800 K	137 - 142	54% - 56%
			4900 K	143 - 148	56% - 58%
			5000 K	149 - 154	58% - 60%
			5100 K	155 - 160	61% - 63%
			5200 K	161 - 166	63% - 65%
			5300 K	167 - 172	65% - 67%
			5400 K	173 - 178	68% - 70%
			5500 K	179 - 184	70% - 72%
			5600 K	185 - 190	73% - 75%
			5700 K	191 - 196	75% - 77%
5800 K	197 - 202	77% - 79%			
5900 K	203 - 208	80% - 82%			
6000 K	209 - 214	82% - 84%			
6100 K	215 - 220	84% - 86%			
6200 K	221 - 226	87% - 89%			
6300 K	227 - 232	89% - 91%			
6400 K	233 - 238	91% - 93%			
6500 K	239 - 244	94% - 96%			
5600 K	245 - 255	96% - 100%			

4	white temperature fine	step	no effect	0		0%	
		proportional	fine white temperature control (from temperature selected to the previous step)	1	- 126	1%	- 49%
		step	no effect	127	- 128	50%	- 50%
		proportional	fine white temperature control (from temperature selected to the following step)	129	- 254	51%	- 99%
		step	no effect	255		100%	
5	strobe effect	step	no effect	0	- 9	0%	- 4%
		proportional	variable speed strobing effect, from slow to fast	10	- 57	4%	- 22%
		step	stop strobe	58	- 59	23%	- 23%
		proportional	sequenced pulse effect, slow closing, fast opening (variable speed pulsing, from slow to fast)	60	- 108	24%	- 42%
		step	stop strobe	109	- 110	43%	- 43%
		proportional	sequenced pulse effect, fast closing, slow opening (variable speed pulsing, from slow to fast)	111	- 159	44%	- 62%
		step	stop strobe	160	- 161	63%	- 63%
		proportional	random strobe effect with variable speed from slow to fast	162	- 207	64%	- 81%
		step	stop strobe	208	- 209	82%	- 82%
		proportional	random strobe effect with variable speed from slow to fast	210	- 255	82%	- 100%
6 ¹	special functions	step	park	0	- 9	0%	- 4%
			no effect	10	- 22	4%	- 9%
			no effect	23	- 84	9%	- 33%
			fan at SILENT mode	85	- 96	33%	- 38%
			fan at STUDIO mode	97	- 108	38%	- 42%
			fan at AUTO mode	109	- 120	43%	- 47%
		proportional	fan speed control	121	- 133	47%	- 52%
		step	enables the automatic display blackout	134	- 185	53%	- 73%
			disables the automatic display blackout	186	- 199	73%	- 78%
			no effect	200	- 255	78%	- 100%

Note 1: **SPECIAL FUNCTIONS** channel is not compatible with **MK1 VERSION**

10. Display panel functions

10.1 Quick guide to menu

To access the functions menus just press the MENU button. Then press + or – buttons to scroll the pages and press the ENTER button to access to any other function.

By suitably using all the functions of **ReLite Led Kit HD +**, which can be activated through its display panel, it is possible to change some of the parameters and to add some functions. Changing the preset settings made by **Coemar** can vary the functions of the projector so that it will respond differently to the controller; therefore carefully read about the functions described here before carrying out any possible selection.

10.2 Rapid count

Through the display panel of **ReLite Led Kit HD +** it is possible to quickly change the various numbers displayed for the different functions in the following 3 manners:

1. Pressing the + or – buttons will cause the count to be quicker.
2. Pressing first + and then – and then holding them down simultaneously will cause the numbers to jump to the highest value.
3. Pressing first – and then + and then holding them down simultaneously will cause the number to jump to the lowest value.



This will be the first screen that will appear on the display once the projector is turned on. To change the DMX address press the “+” button and choose the DMX address desired.

N.B. If the projector is not connected to the DMX signal, A001 will blink intermittently

Fixed White Version

10.3 Main functions menu

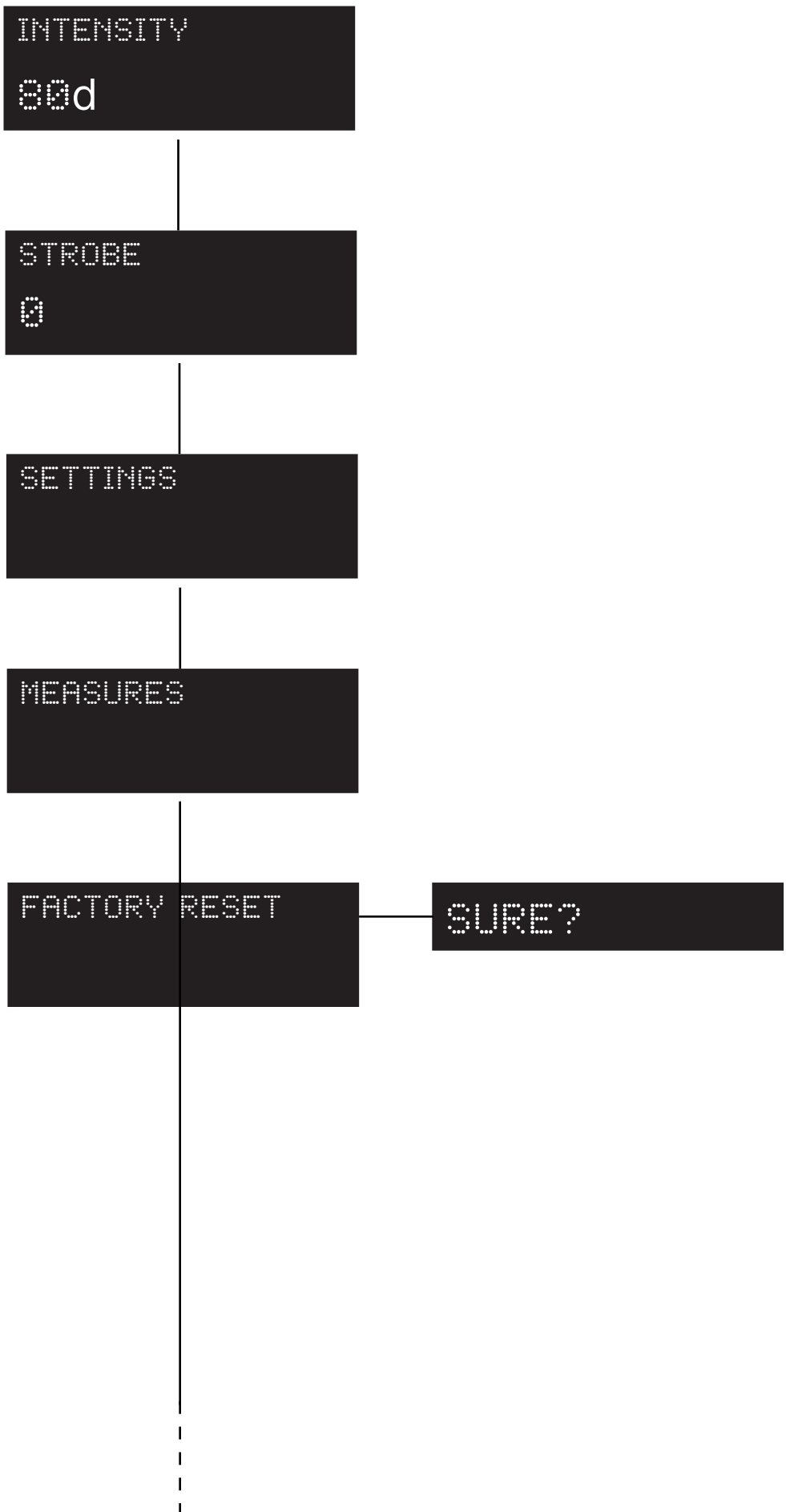

INTENSITY:

Allows to adjust the luminous output intensity from 0 to 255 (d: decimal units).

STROBE:

Manually sets the strobe DMX channel.

SETTINGS:

Manually sets various settings of the projector.

MEASURES:

Check all the measures and product status.

FACTORY RESET:

Allows to return to the factory settings:
Light Intensity: 80
DMX Channels: 5
Fan: Auto mode
Strobe: 0
Frequency: 600 Hz

10.4 Settings

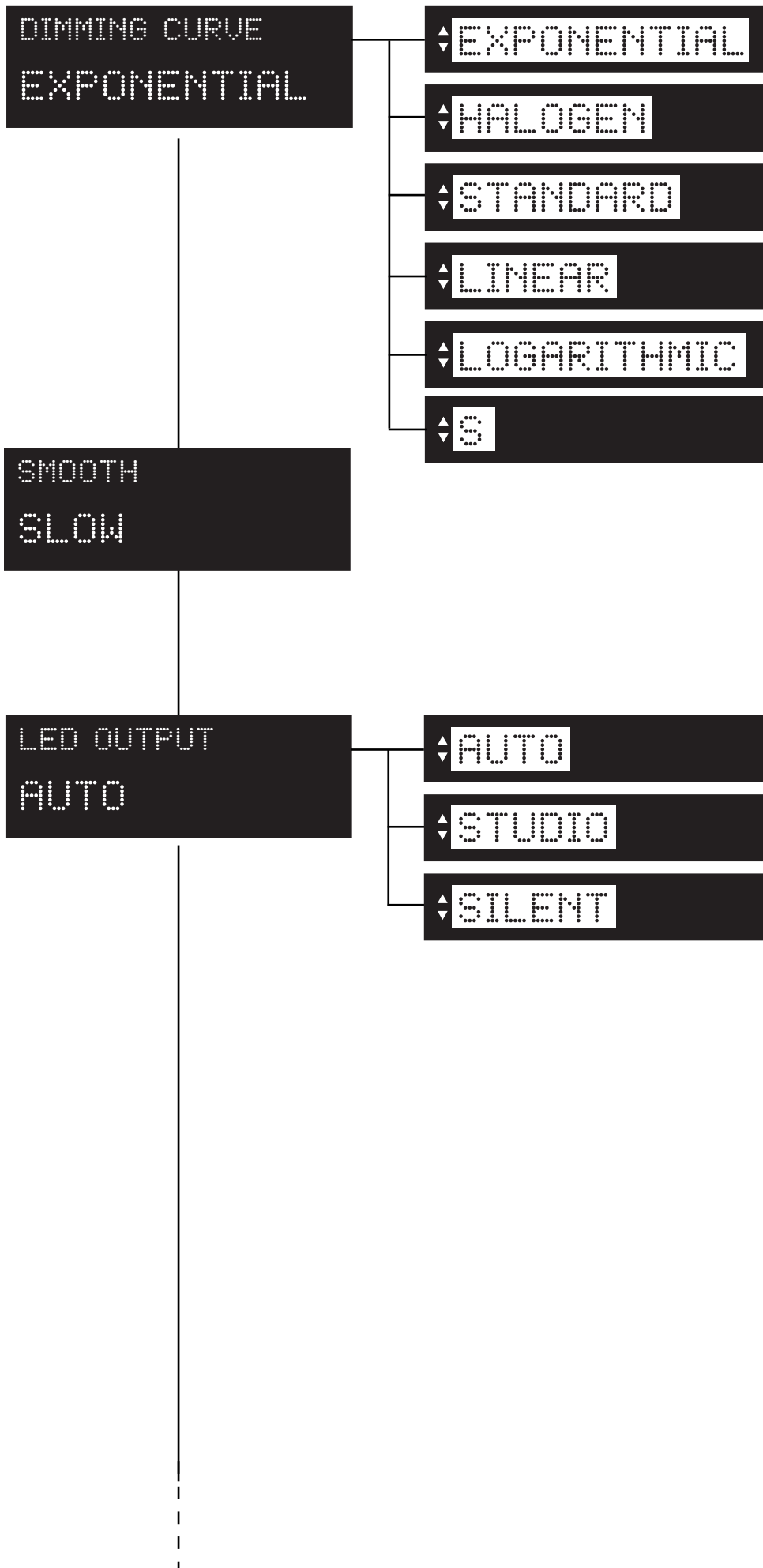

DIMMING CURVE:

It allows the selection of different dimmer curves: exponential (default), halogen, standard, linear, logarithmic and S.

SMOOTH:

Allows to change the speed of every dimming curve between **FAST** (standard), **SLOW**, **VERY SLOW**.

LED OUTPUT:

Manually sets the fan mode.

AUTO: Fan with automatic operating speed to guarantee maximum light output in all conditions of use, ideal for live events, exhibitions and architectural installations.

STUDIO: Fan at automatic operation speed with limited speed to guarantee silent operation of the product (moderately limited light output, will decrease in case of overheat) ideal for broadcast or theatre applications.

SILENT: This setting will keep the speed of the fan at the minimum level (moderately limited light output, will decrease in case of overheat) ideal for environments that require maximum silence.

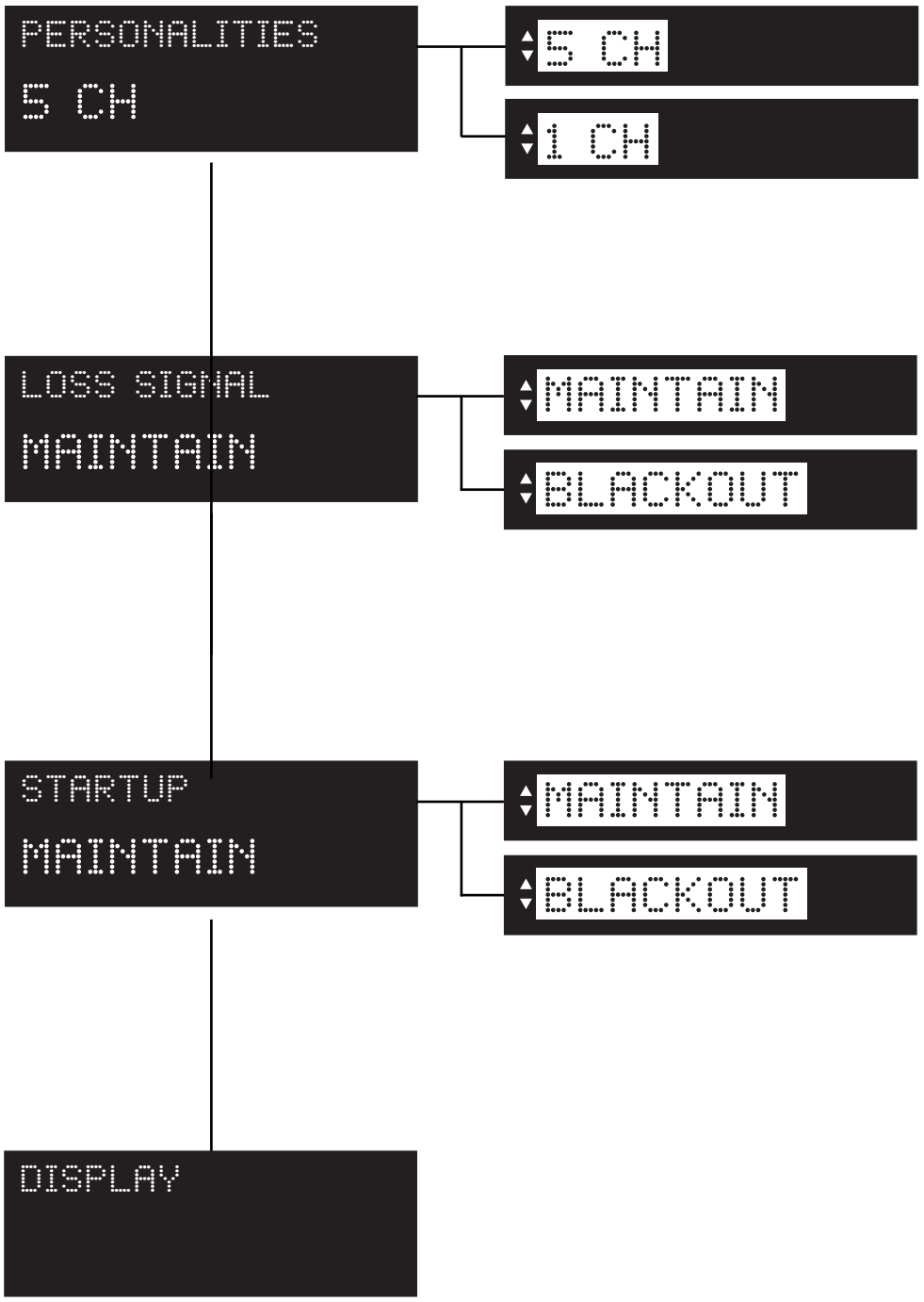

PERSONALITIES:

It is possible to choose between **5** channels or **1** channel, in which the projector will operate.

LOSS SIGNAL:

It is possible to choose between “maintain” (this function allows to keep the settings even in case of **LOSS SIGNAL**) and “blackout” (in case of **LOSS SIGNAL**, the projector will go into blackout).

STARTUP:

It is possible to choose between “maintain” (this function allows to keep the settings in case of **STARTUP**) and “blackout” (in case of **STARTUP**, the projector will go into blackout).

DISPLAY:

Display settings.

10.5 Display

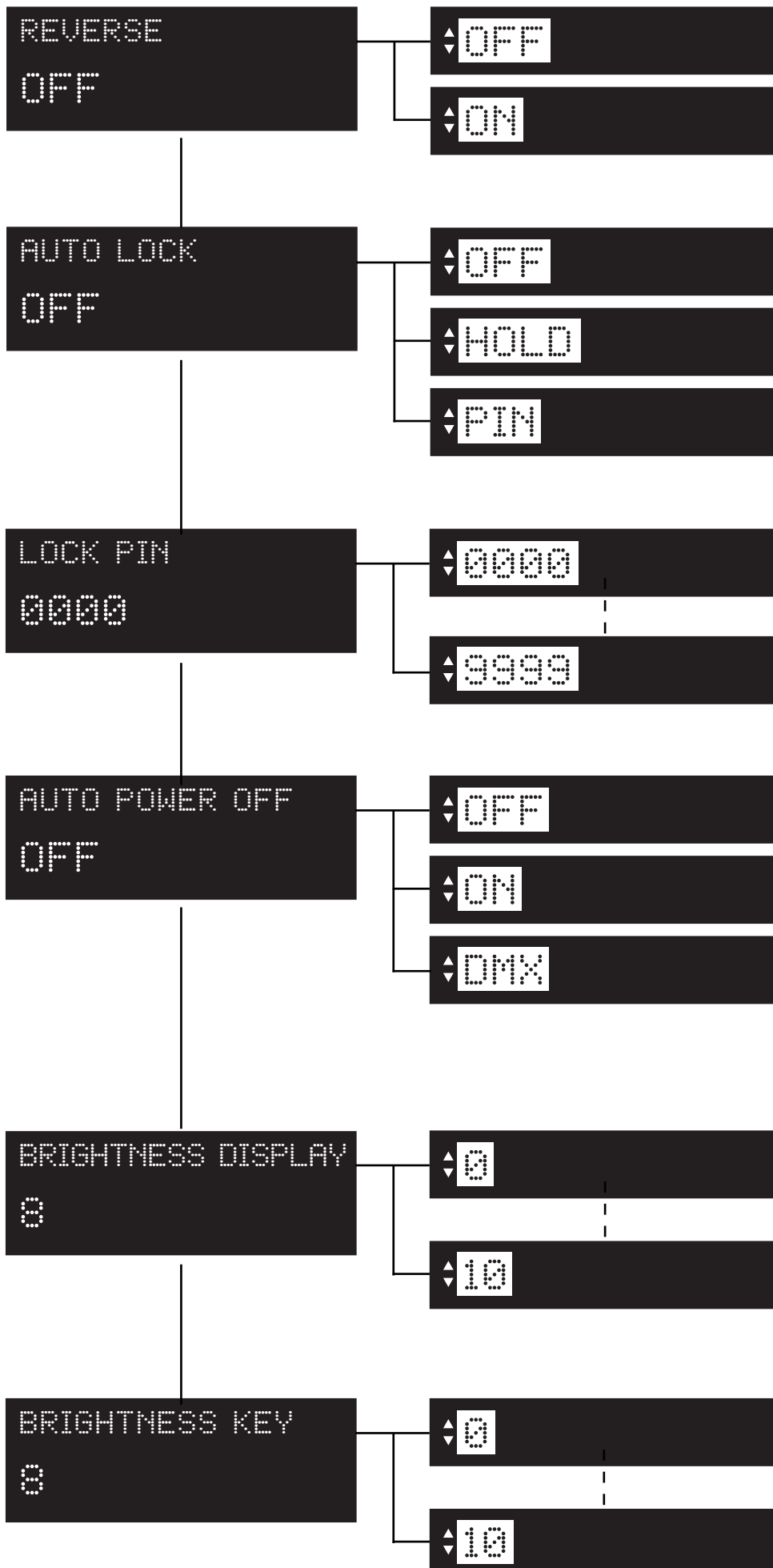

REVERSE:

It allows to turn by 180° the reading of the display. When you chose "ON" wait the turn of the display without clicking.

AUTO LOCK:

Locks the keys.

OFF: Auto Lock function in OFF

HOLD: Press any key for 3 seconds to unlock.

PIN: Use your personal lock pin to unlock.

LOCK PIN:

Allows to set your personal lock pin (from 0000 to 9999).

AUTO POWER OFF:

OFF: Auto Power OFF in OFF

ON: Causes the projector display to turn off after 30 seconds of inactivity.

DMX: Causes the projector display to turn off after 30 seconds of inactivity, but the display will turn automatically ON in case of signal loss

BRIGHTNESS DISPLAY:

Allows to change the brightness of the display (from 0 to 10).

BRIGHTNESS KEY:

Allows to change the brightness of the key (from 0 to 10).

10.6 Measures

```
TEMPERATURES
 ° F   MIN NOW MAX
LED:  -°C -°C -°C
BOARD: -°C -°C -°C
```

```
TEMP HISTORIES
 ° F   MIN NOW MAX
LED:  -°C -°C -°C
BOARD: -°C -°C -°C
```

```
DMX INPUT
1  0
```

```
1
5
```

```
DMX REFRESH RATE
0 HZ
```

```
FAN STATUS
      %   RPM
LED:  -   -
AUX:  -   -
```

TEMPERATURES:

Shows the current temperature values of the fixture.

LED: shows the LED module temperature.

BOARD: shows the electronic board temperature.

TEMPERATURES HISTORIES:

Shows the history temperature of the fixture.

LED: shows the LED module temperature.

BOARD: shows the electronic board temperature.

DMX INPUT:

Shows the value of the DMX channels received by the fixture on every channel (from 1 to 5) that the fixture occupies on the line.

DMX REFRESH RATE:

Shows the refresh rate of the DMX signal sent by the console.

FAN STATUS:

Shows the percentage fan usage.

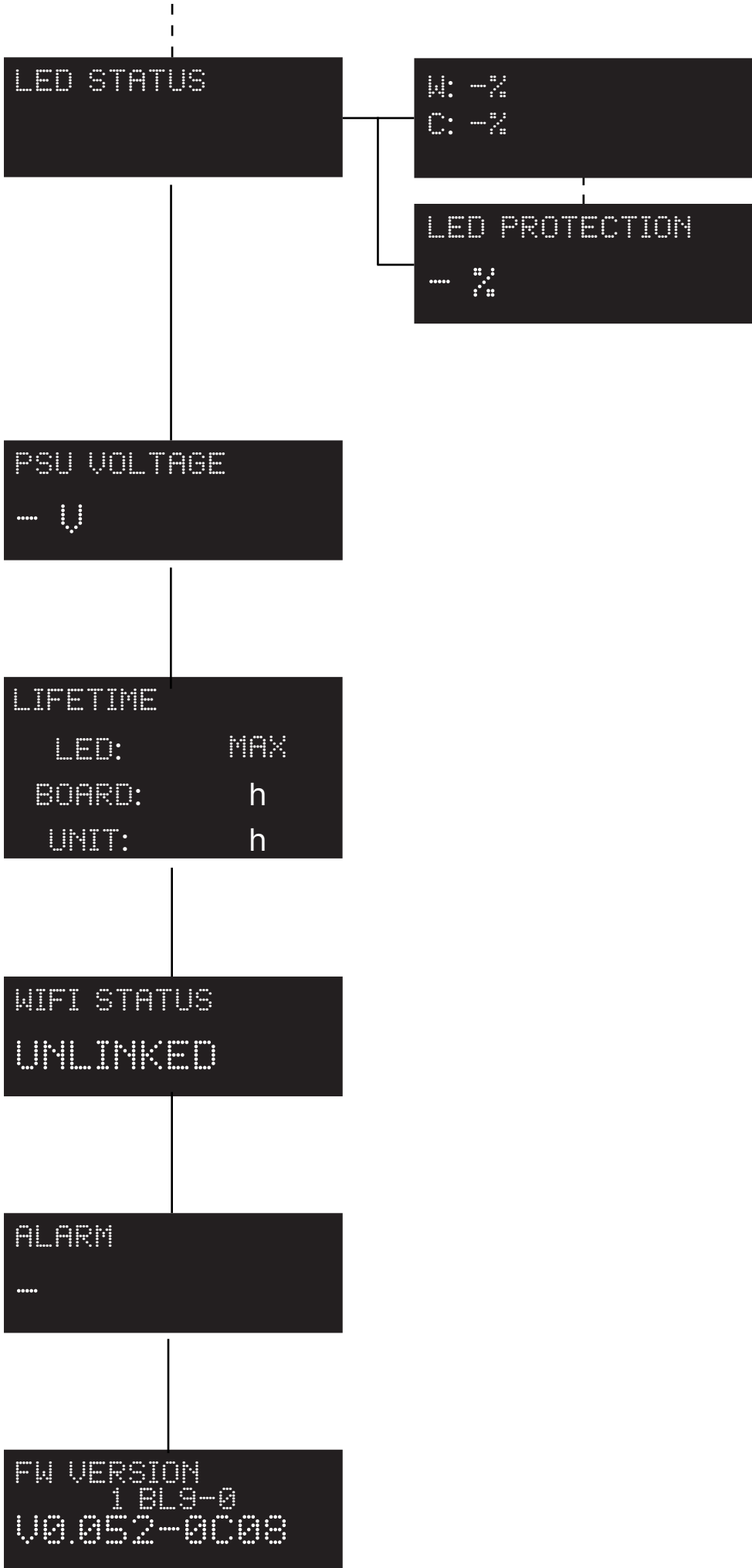

LED STATUS:

Shows the percentage value of the LED status.

LED PROTECTION:

Percentage of the maximum power in order to keep the projector in temperature.

PSU VOLTAGE:

Shows the power supply voltage.

LIFETIME:

Shows the hour counter of the fixture.

LED: shows the overall LED module life.

BOARD: shows the overall LED module life currently installed. **UNIT**

LIFE: shows the overall hours of life of the fixture.

Note: this items can be reset in case of LED module replacement.

ALARM:

This menu eventually shows the alarm statuses if there is any.

FIRMWARE VERSION:

Shows the firmware version currently installed in the fixture (as you can see in the example).

VariWhite Version

10.7 Main functions menu

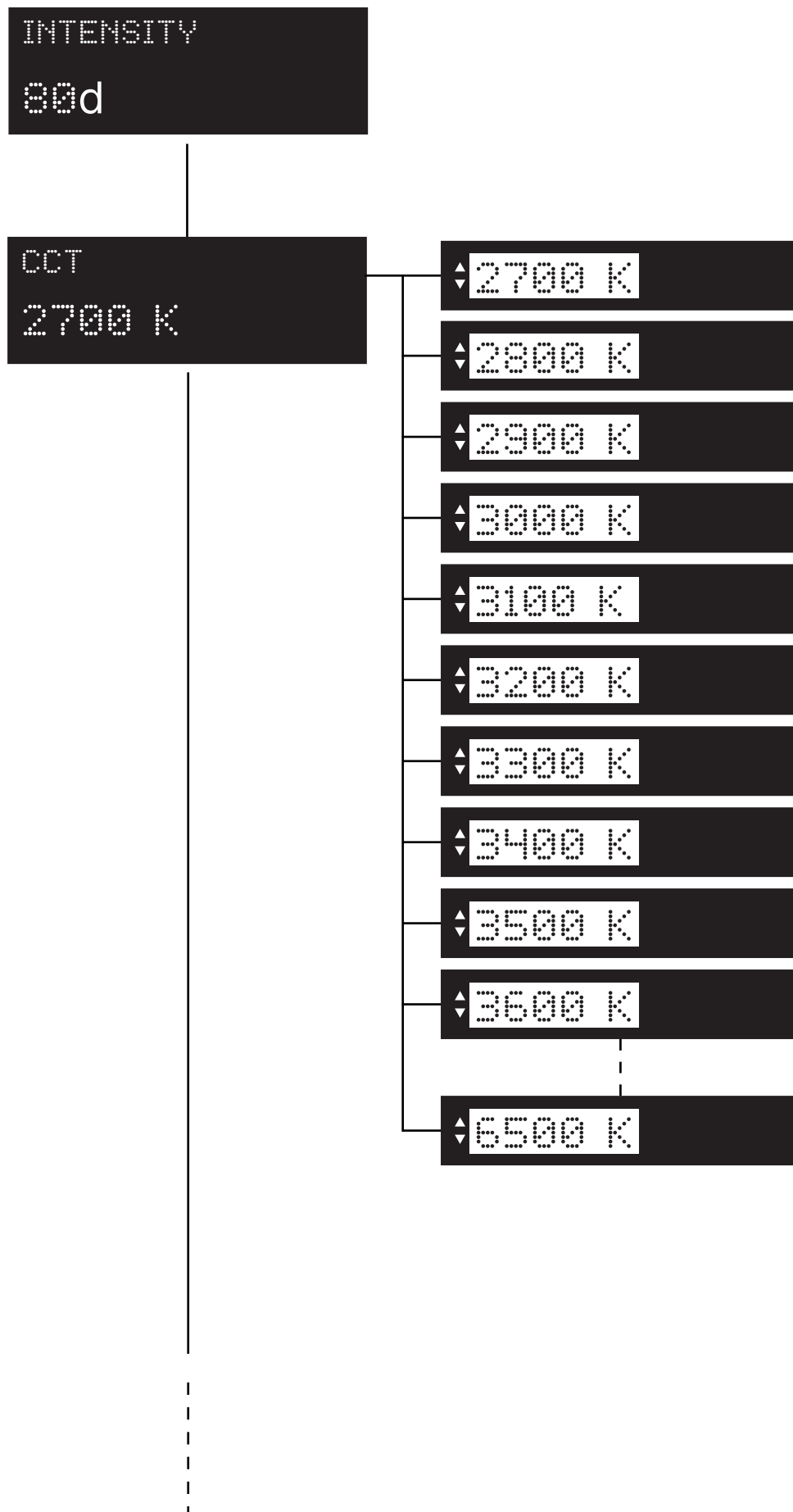

INTENSITY:

Allows to adjust the luminous output intensity from 0 to 255 (d: decimal units).

CCT:

This channel offers a preset library of various white CCT with a range that goes from 2.700 K and up to 6.500 K, manually selectable without the need of a DMX console.

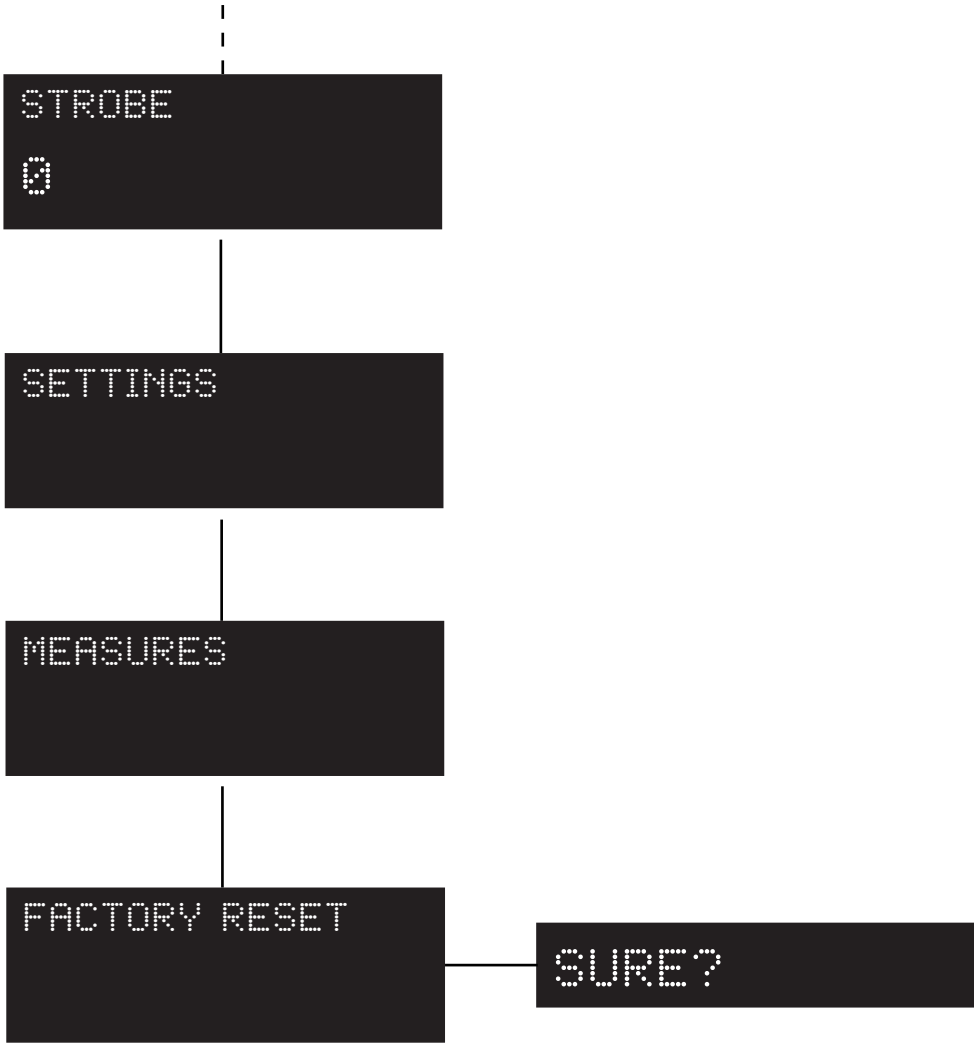

STROBE:
Manually sets the strobe DMX channel.

SETTINGS:
Manually sets various settings of the projector.

MEASURES:
Check all the measures and product status.

FACTORY RESET:
Allows to return to the factory settings:
Light Intensity: 80
CCT: 4.400 K
DMX Channels: 5
Fan: Auto mode
Strobe: 0

10.8 Settings

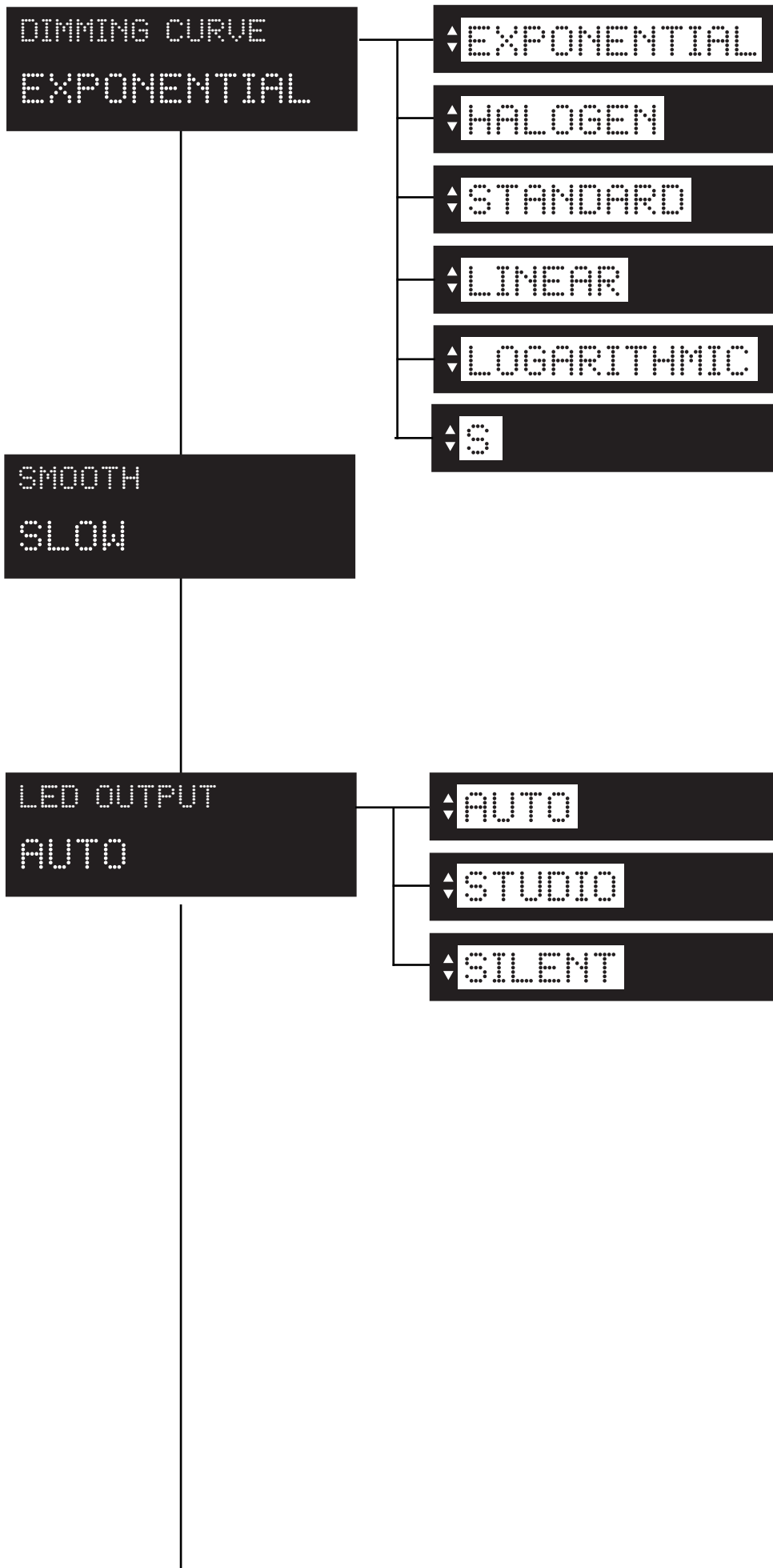

DIMMING CURVE:

It allows the selection of different dimmer curves: exponential (default), halogen, standard, linear, logarithmic and S.

SMOOTH:

Allows to change the speed of every dimming curve between **FAST** (standard), **SLOW**, **VERY SLOW**.

LED OUTPUT:

Manually sets the fan mode. **AUTO:** Fan with automatic operating speed to guarantee maximum light output in all conditions of use, ideal for live events, exhibitions and architectural installations.

STUDIO: Fan at automatic operation speed with limited speed to guarantee silent operation of the product (moderately limited light output, will decrease in case of overheat) ideal for broadcast or theatre applications.

SILENT: This setting will keep the speed of the fan at the minimum level (moderately limited light output, will decrease in case of overheat) ideal for environments that require maximum silence.

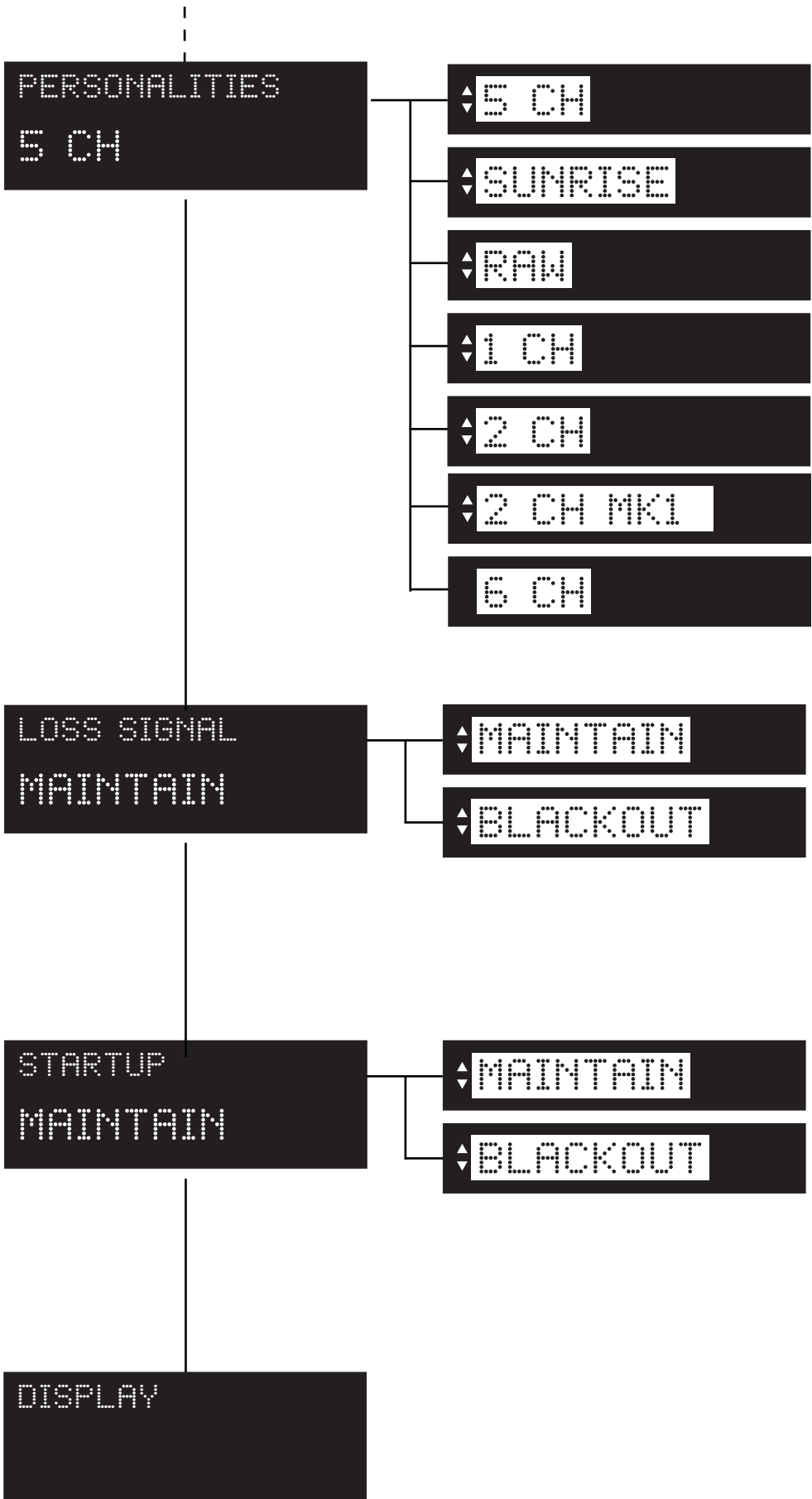

PERSONALITIES:

It is possible to choose between **5**, **SUNRISE**, **RAW**, **1** or **2** modalities, in which the projector will operate.

LOSS SIGNAL:

It is possible to choose between “maintain” (this function allows to keep the settings even in case of **LOSS SIGNAL**) and “blackout” (in case of **LOSS SIGNAL**, the projector will go into blackout).

STARTUP:

It is possible to choose between “maintain” (this function allows to keep the settings in case of **STARTUP**) and “blackout” (in case of **STARTUP**, the projector will go into blackout).

DISPLAY:

Display settings.

10.9 Display

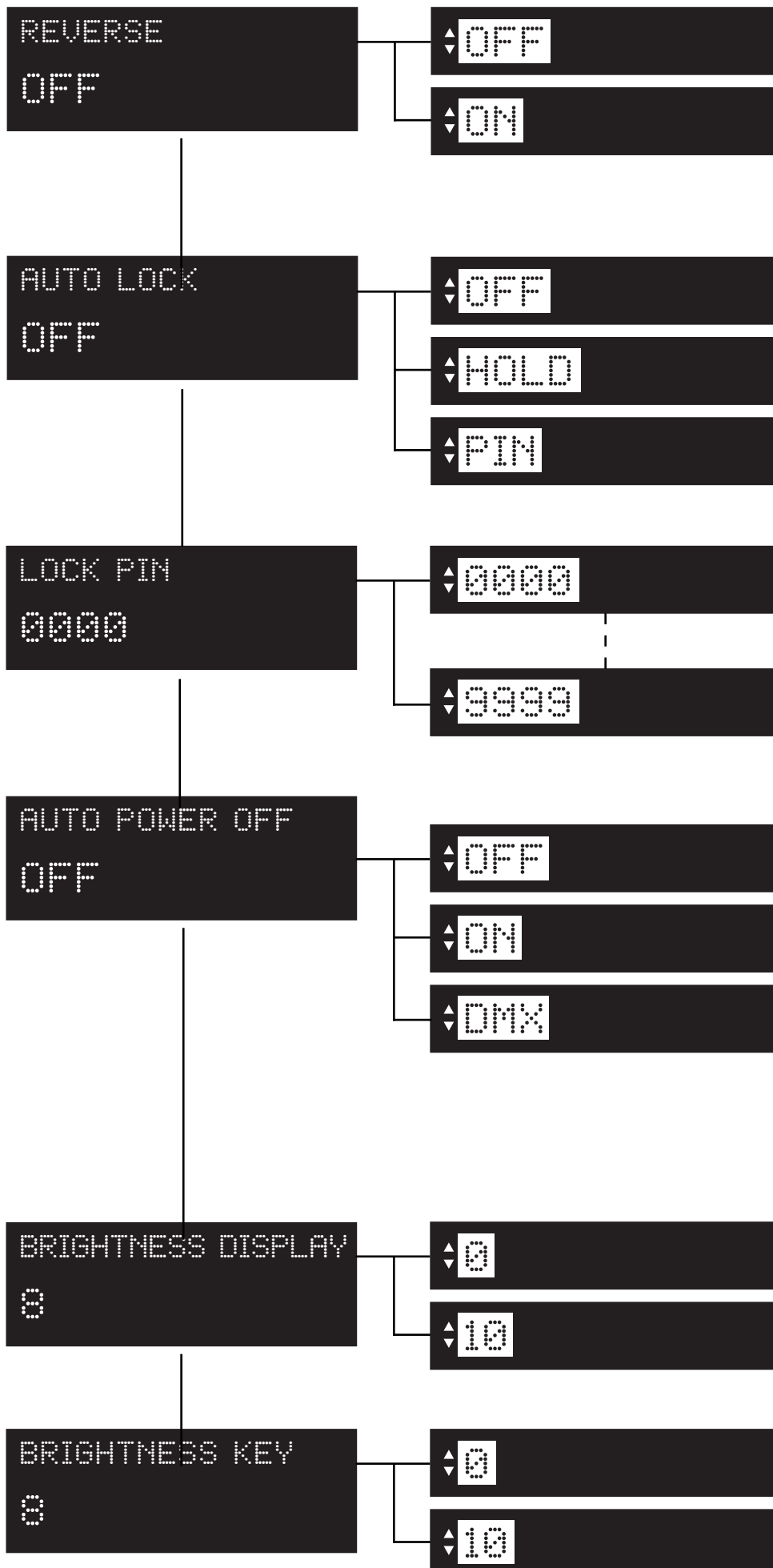

REVERSE:

It allows to turn by 180° the reading of the display. When you chose "ON" wait the turn of the display without clicking.

AUTO LOCK:

Locks the keys.
OFF: Auto Lock function in OFF
HOLD: Press any key for 3 seconds to unlock.
PIN: Use your personal lock pin to unlock.

LOCK PIN:

Allows to set your personal lock pin (from 0000 to 9999).

AUTO POWER OFF:

OFF: Auto Power OFF in OFF
ON: Causes the projector display to turn off after 30 seconds of inactivity.
DMX: Causes the projector display to turn off after 30 seconds of inactivity, but the display will turn automatically ON in case of signal loss

BRIGHTNESS DISPLAY:

Allows to change the brightness of the display (from 0 to 10).

BRIGHTNESS KEY:

Allows to change the brightness of the key (from 0 to 10).

10.10 Measures

```
TEMPERATURES
 ° F   MIN NOW MAX
LED:  -°C -°C -°C
BOARD: -°C -°C -°C
```

```
TEMP HISTORIES
 ° F   MIN NOW MAX
LED:  -°C -°C -°C
BOARD: -°C -°C -°C
```

```
DMX INPUT
1  0
```

```
▲ 1
▼
```

```
▲ 5
▼
```

```
DMX REFRESH RATE
0 HZ
```

```
FAN STATUS
      %   RPM
LED:  -   -
AUX:  -   -
```

TEMPERATURES:

Shows the current temperature values of the fixture.

LED: shows the LED module temperature.

BOARD: shows the electronic board temperature.

TEMPERATURES HISTORIES:

Shows the history temperature of the fixture.

LED: shows the LED module temperature.

BOARD: shows the electronic board temperature.

DMX INPUT:

Shows the value of the DMX channels received by the fixture on every channel (from 1 to 5) that the fixture occupies on the line.

DMX REFRESH RATE:

Shows the refresh rate of the DMX signal sent by the console.

FAN STATUS:

Shows the percentage fan usage.

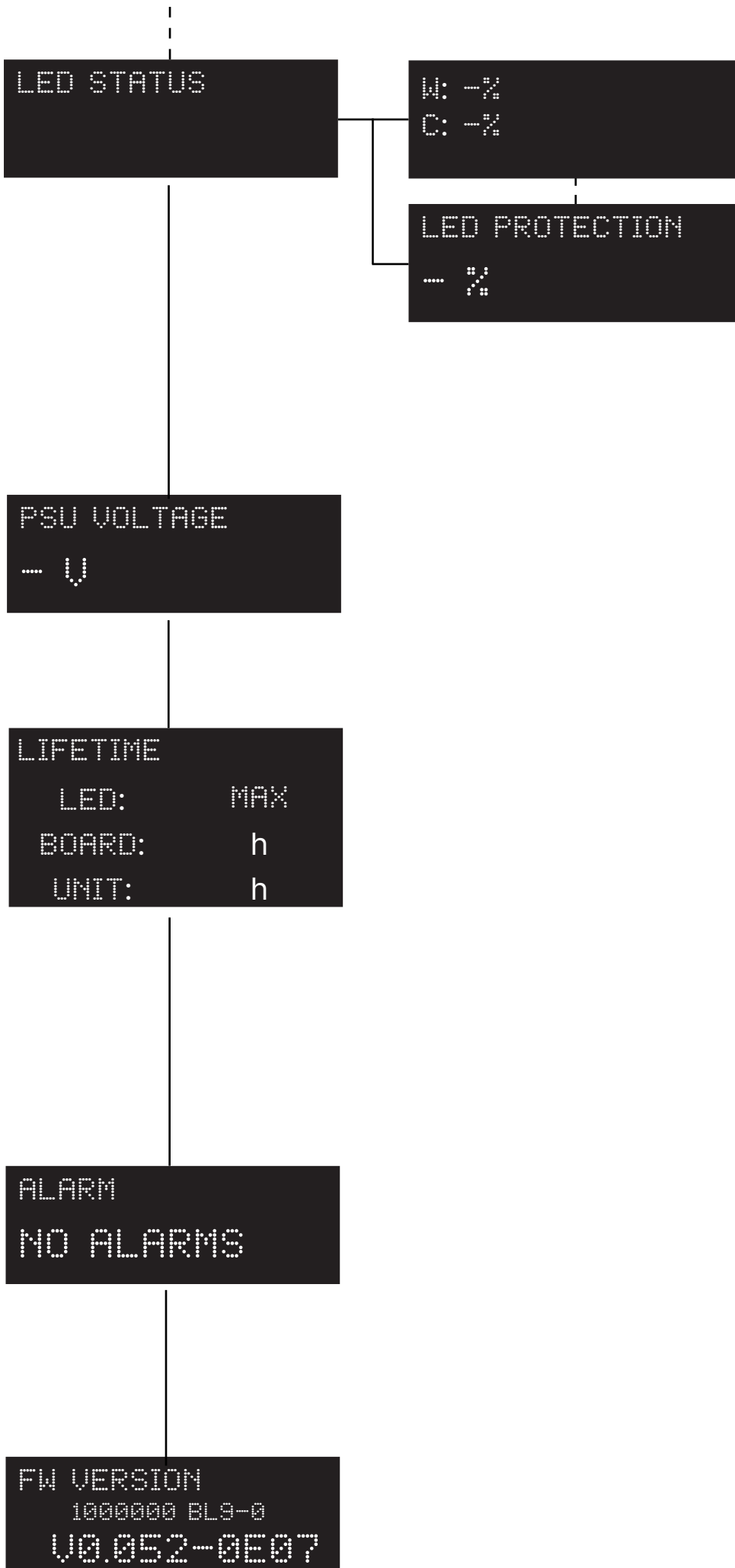

LED STATUS:

Shows the percentage value of the LED status.

LED PROTECTION:

Percentage of the maximum power in order to keep the projector in temperature.

PSU VOLTAGE:

Shows the power supply voltage.

LIFETIME:

Shows the hour counter of the fixture.

LED: shows the overall LED module life.

BOARD: shows the overall LED module life currently installed. **UNIT**

LIFE: shows the overall hours of life of the fixture.

Note: this items can be reset in case of LED module replacement.

ALARM:

This menu eventually shows the alarm statuses if there is any.

FIRMWARE VERSION:

Shows the firmware version currently installed in the fixture (as you can see in the example).

10.11 Special functions of the fixture

Storing the DMX signal

To use the fixture without an active DMX console it is possible to store the DMX settings in two ways:

- Through the **WHITE PRESET** menu;
- Disconnecting the DMX signal when the fixture is on. When the signal is unconnected the fixtures stores the signal;

Automatic fans standby

To decrease the noise and the power consumption the cooling fans (the LED one and the Electronics one) turns off after 40 seconds without emitting light.

10.12 Error messages

If a malfunction occurs, **ReLite Led Kit HD +** has a self-diagnostic system that will show the error message on the display. The following table will explain in detail the most common errors. If, despite of suggested intervention, the problem persists, call the **Coemar** Service Center.

Error code	Description
MEMORY	Memory Error Indicates that the projector has lost its memory and saved data
HW MEMORY	HW Memory Error Indicates that there is an Hardware Memory Error
DMX ADDR	DMX Address Error The projector address is too high and does not allow to receive all the necessary channels. We recall in this connection that some controllers do not generate all the 512 channels.
NTC ERROR	NTC Error LED temperature sensor missing or damaged.
SHORT NTC	Short NTC Error Error of the LED's sensor circuit.
FAN SPEED	Fan Speed Error Auto diagnostic routine found that the Fan may be damaged, contact Coemar assistance for the module replacement. IMPORTANT: to ensure the sensor is giving correct readings or that the fan rotates correctly, set the fan to the maximum level.
OVERTEMP	Over temperature Error Indicates that the product has reached a too high temperature.

11. Spare parts

All **ReLite Led Kit HD +**'s spare parts are available from your Coemar service centers. Specifying in detail the projector model and the replacement part requested, will help the service center to serve you in the best way.

12. Maintenance

12.1 Periodic cleaning

Cleaning of the unit

Use a soft brush or a common vacuum cleaner or a source of compressed air for removing dust. For the cleaning of the housing use a soft cloth and a non-aggressive cleaner. Check that the fan and heat exchanger must be perfectly clean.

12.2 Periodic controls

Mechanical components

Check the correct working of the mechanical parts and, if needed, replace them. Make sure the projector is not mechanically damaged. If necessary, replace the worn parts.

13. F.A.Q. and answers

The following list shows common issues that may be simply solved. If issues persist, the unit must be repaired by qualified personnel or just contact your **Coemar** service near you.

Question	Possible solution
ReLite Led Kit HD + does not emit light	Projector not powered: <ul style="list-style-type: none">• Make sure the power cord is plugged in or test the input voltage in the projector in which ReLite Led Kit HD + is installed;• Make sure the ReLite Led Kit HD + is well inserted into the socket.



Information on disposal of the equipment

The equipment at the end of its useful life must be disposed of at an appropriate recycling center for waste electrical and electronic equipment. The treatment and disposal of environmentally friendly, helps prevent potential negative environmental and health and promote the reuse and / or recycling of materials making up the equipment. Illegal disposal by the user includes the application of administrative sanctions provided by law.



Coemar Lighting s.r.l.

Via Carpenedolo 90
46043 Castiglione delle Stiviere, Mantova, Italia
tel. +39 0376/1514412 - fax +39 0376/1514380
info@coemar.com

Coemar reserves the right to change specifications without prior notice