

# LEDko EXT T+

Product code:  
F129E001A (CRI 80)  
F129C001A (CRI 90)

Last update:  
01/07/2024



## LEDko EXT T +

### Introducing

● Outdoor LED profile fixture. This IP 65 rated fixture replicates the performance of the indoor version. It comes in different fixed versions of CCT (3.200 K or 5.600 K) or FullSpectrum color (RGBLA). The LEDko EXT includes a four blade framing system with gobo holder and zoom lens system ranging from 14° to 35°, 10° to 25° or from 30° to 60° and optic 80°; bare ends power input cable and in/out 5 pin XLR IP 65 rated connectors for the DMX signal. The display is lockable thanks to a freely selectable security pin code. Designed with new electronic and a new OLED display, this spot profile projector is the evolution of the FullSpectrum. The + electronic with advanced LED controller enables a smooth dimming and it offers and higher luminous efficiency.

### Key Features

- LED Profile Spot IP65 for permanent Outdoor installation
- Tungsten COB LED
- CRI > 80, CRI > 90
- CCT Fixed White 3.200 K
- Profile zoom from 14° to 35°, 10° to 25°, 30° to 60° and optic 80°
- Four blade framing system, each shutter blade is adjustable for radial position and angle
- Internal gobo holder
- Die-cast aluminium (Anti-Salt treatment)
- Black, custom color on request (optional)

General	
● LED Source	Tungsten COB LED
● CCT Range	●●●●● Fixed White 3.200 K
● Color Rendition Average	CRI> 80, CRI>90
● Dimming	8 or 16bit, 5 selectable curves: Exponential, Logarithmic, Linear, Halo and Standard
● Dimming Smooth Selection	Fast, Slow and Very Slow
● Strobe	Synchronized, random or pulse electronic strobe
● Available Optics	Profile zoom from 14° to 35°, 10° to 25°, 30° to 60° and optic 80°
● Camera flicker control/Hz range	Yes, from 600 Hz to 20.000 Hz
● Calibrated Cob	Yes
● L80 Rating (hours to 80% output)	50.000 Hours
● Pattern projection	Yes
● Pattern size	A or B Gobo outside diameter= 86 mm / 3.38 in Max image diameter= 64.5 mm / 2.53 in
Electrical	
● Voltage Input	80-264 V 50/60 Hz, auto sensing
● Power Consumption	200 W Maximum - 0.92 A at 230 V, 1.83 A at 115 V - cosφ 0,95
● Power Connection	1.5 m (4.9 ft) Integral cable Bare Ends
● Data Connection	In/Out IP65 DMX Signal Junction Connector (Cod Art. RCN 73)
Thermal	
● Ambient Operating Temperature	-40°C - +40°C (-40°F - 104°F)
● Fan (controllable)	Yes, 4 different settings: Silent, Studio, Auto, DMX Regulated
Control	
● Protocols	DMX512A, RDM (Remote Device Management), Wireless (Optional By LumenRadio)
● RDM	DMX Setup, Fixture Status, RDM Commands (only DMX version)
● DMX Channels	5 / 1
● Display	Graphic OLED
● Software upload	Through DMX input (With RDM interface code AC10011A001)
Physical	
● Mounting options	Yoke
● Materials	Die-cast aluminium (Anti-Salt treatment)
● Framing System	Four blade framing system, each shutter blade is adjustable for radial position and angle
● IP Rating	IP65
● Color options	Black (standard), custom color on request (optional)
Optics	
BC10029A002	Profile Zoom 10°-25°
BC10029A000	Profile Zoom 14°-35°
BC10029A004	Profile Zoom 30°-60°
BC10029A005	Lens Tube Profile 80°
General accessories	
BC10028A000	Removable four blade framing system with gobo holder
BC10029A003	Frame Holder (included)
BC10029A100	LEDko EXT DMX wireless kit
RME34/G	DMX end of line closure cap (indispensable for the last projector of the line)

**5 Channels**

- 01 → Master Dimmer
- 02 → Spare Channel
- 03 → Dimmer Fine
- 04 → Strobe Effect
- 05 → Special Function

**1 Channel**

- 01 → Master Dimmer - Color Temperature Settable by Display

**Drawing Size**

**LEDko EXT 80° Optic**

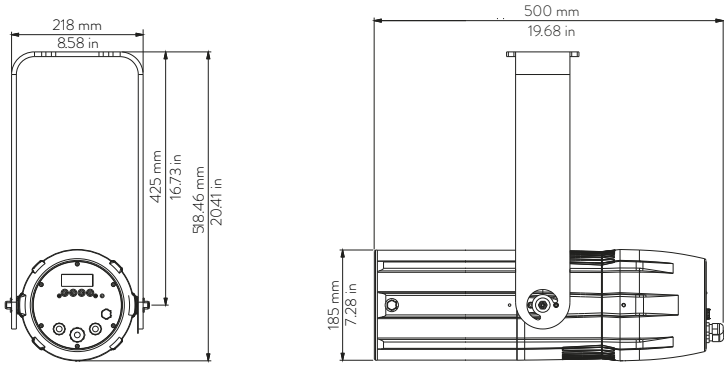

Length	Width	Height	Weight
500 mm 19.68 in	252.6 mm 9.94 in	185 mm 7.28 in	12.1 Kg 26.6lbs

With  
bracket:  
518.46 mm  
20.41 in

**LEDko EXT 30°-60° Zoom**

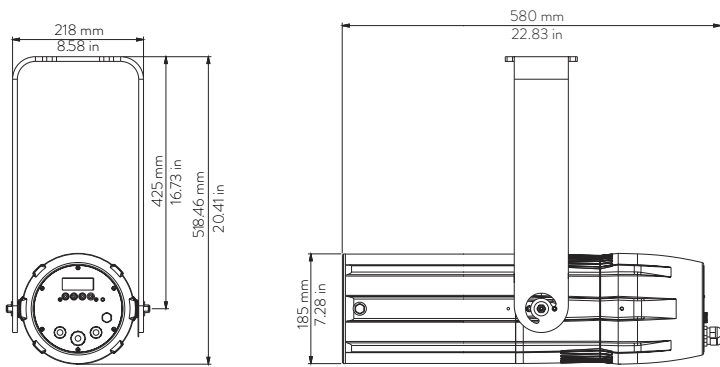

Length	Width	Height	Weight
580 mm 22.83 in	252.6 mm 9.94 in	185 mm 7.28 in	12.6 Kg 27.7 lbs

With  
bracket:  
518.46 mm  
20.41 in

**LEDko EXT 14°-35° Zoom**

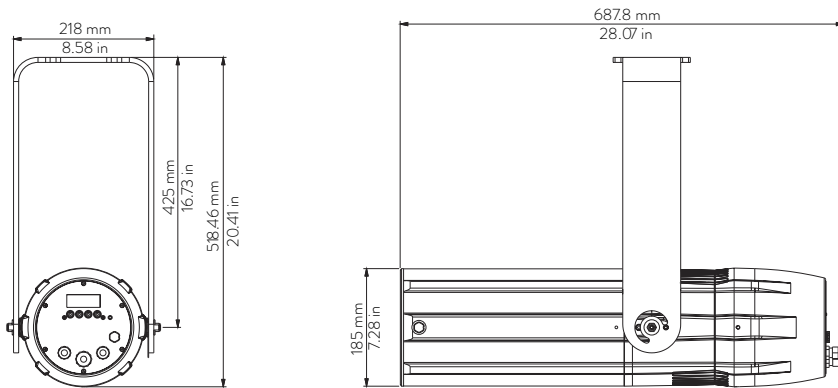

Length	Width	Height	Weight
687.8 mm 27.07 in	252.6 mm 9.94 in	185 mm 7.28 in	14 Kg 30.8 lbs

With  
bracket:  
518.46 mm  
20.41 in

**LEDko EXT 10°-25° Zoom**

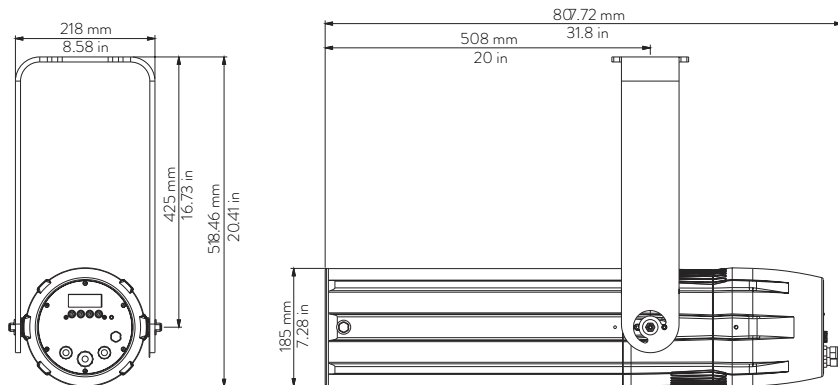

Length	Width	Height	Weight
807.2 mm 31.8 in	252.6 mm 9.94 in	185 mm 7.28 in	15 Kg 33.1 lbs

With  
bracket:  
518.46 mm  
20.41 in

Mounting yoke attachment point

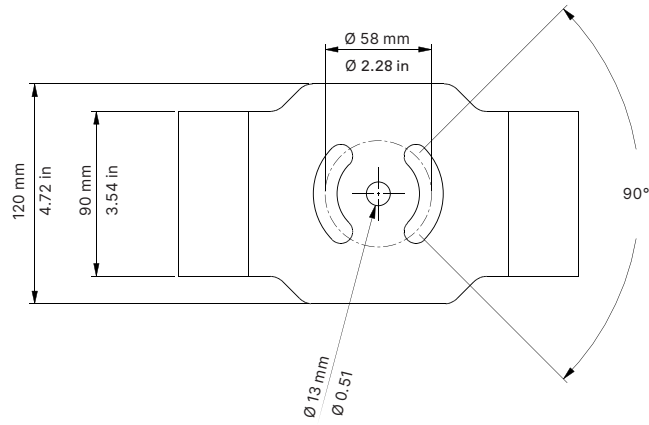

Accessories

Iris (optional)



DMX Signal Junction Connector

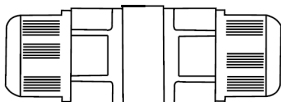

Specification

- DMX 512 STANDARD:
- Pin 1 = Ground Wire
- Pin 2 = Negative (Black)
- Pin 3 = Positive (White)



Architectural Outdoor - Pitti Palace, Florence, Italy

Product	LEDko EXT T
CCT	3.200K
CRI	>90



Architectural Outdoor - Pitti Palace, Florence, Italy

Product	LEDko EXT T
CCT	3.200K
CRI	>90



## LEDko EXT Tungsten CRI 90 - Zoom Profile 10°-25°

### Optic: Minimum Zoom

<b>Distance(m)</b>	3	6	9	12	15	18	21	24	27	30	
<b>lux</b>	<b>3.200K</b>	36.720	9.180	4.080	2.295	1.469	1.020	749	574	453	367
<b>Diameter Ø (m)</b>	0,63	1,26	1,89	2,52	3,15	3,78	4,41	5,05	5,68	6,31	
<b>lux</b>	<b>3.200K</b>	CRI 90	TLCI 90								

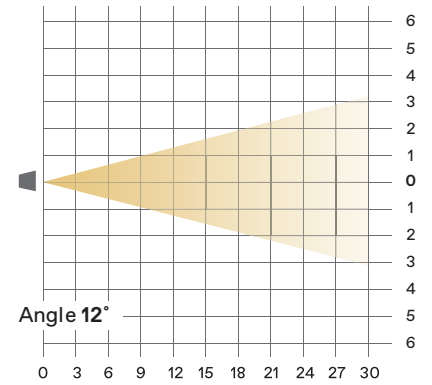

### Optic: Medium Zoom

<b>Distance(m)</b>	3	6	9	12	15	18	21	24	27	30	
<b>lux</b>	<b>3.200K</b>	21.400	5.350	2.378	1.338	856	594	437	334	264	214
<b>Diameter Ø (m)</b>	0,90	1,79	2,69	3,59	4,48	5,38	6,28	7,17	8,07	8,97	
<b>lux</b>	<b>3.200K</b>	CRI 90	TLCI 90								

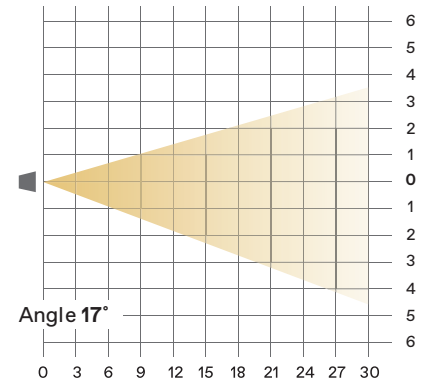

### Optic: Maximum Zoom

<b>Distance(m)</b>	3	6	9	12	15	18	21	24	27	30	
<b>lux</b>	<b>3.200K</b>	14.401	3.600	1.600	900	576	400	294	225	178	144
<b>Diameter Ø (m)</b>	1,17	2,33	3,50	4,67	5,83	7,00	8,16	9,33	10,50	11,66	
<b>lux</b>	<b>3.200K</b>	CRI 90	TLCI 90								

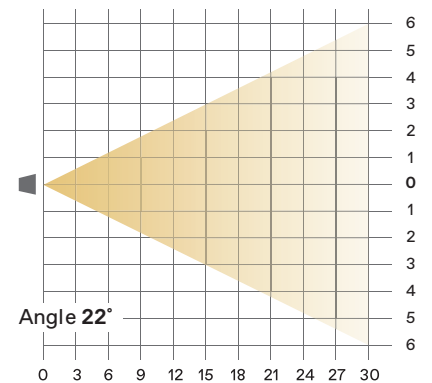

● Coemar Lighting S.r.l.

Via Carpenedolo, 90  
46043, Castiglione delle Stiviere (MN) – Italy

P. +39 0376 1514412

M1. info@coemar.com

M2. service@coemar.com

W. coemar.com

P.iva – C.f. 02415330204

