



LEDko EXT D +

Product code:
F129D001A

Last update:
27/02/2025



LEDko EXT D +

Introducing

● Outdoor LED profile fixture. This IP 65 rated fixture replicates the performance of the indoor version. It comes in different fixed versions of CCT (3.200 K or 5.600 K) or FullSpectrum color (RGBLA). The LEDko EXT includes a four blade framing system with gobo holder and zoom lens system ranging from 14° to 35°, 10° to 25° or from 30° to 60° and optic 80°; bare ends power input cable and in/out 5 pin XLR IP 65 rated connectors for the DMX signal. The display is lockable thanks to a freely selectable security pin code. Designed with new electronic and a new OLED display, this spot profile projector is the evolution of the FullSpectrum. The + electronic with advanced LED controller enables a smooth dimming and it offers and higher luminous efficiency.

Key Features



- LED Profile Spot IP65 for permanent Outdoor installation
- Daylight COB LED



- CRI > 90



- CCT Fixed White 5.600 K



- Profile zoom from 14° to 35°, 10° to 25°, 30° to 60° and optic 80°



- Four blade framing system, each shutter blade is adjustable for radial position and angle



- Internal gobo holder



- Die-cast aluminium (Anti-Salt treatment)



- Custom color on request (optional)

General	
● LED Source	Daylight COB LED
● CCT Range	●●●●● Fixed White 5.600 K
● Color Rendition Average	CRI>90
● Dimming	8 or 16bit, 6 selectable curves: Exponential, Logarithmic, Linear, Halo, Standard and S
● Dimming Smooth Selection	Fast, Slow and Very Slow
● Strobe	Synchronized, random or pulse electronic strobe
● Available Optics	Profile zoom from 14° to 35°, 10° to 25°, 30° to 60° and optic 80°
● Camera flicker control/Hz range	Yes, from 600 Hz to 20.000 Hz
● Calibrated Cob	Yes
● L80 Rating (hours to 80% output)	50.000 Hours
● Pattern projection	Yes
● Pattern size	A or B Gobo outside diameter= 86 mm / 3.38 in Max image diameter= 64.5 mm / 2.53 in
Electrical	
● Voltage Input	80-264 V, 50/60 Hz, auto sensing
● Power Consumption	200 W Maximum - 0.92 A at 230 V, 1.83 A at 115 V - cosφ 0,95
● Power Connection	1.5 m (4.9 ft) Integral cable Bare Ends
● Data Connection	In/Out IP65 DMX Signal Junction Connector (Cod Art. RCN 73)
Thermal	
● Ambient Operating Temperature	-40°C - +40°C (-40°F - + 104° F)
● Fan (controllable)	Yes, 4 different settings: Silent, Studio, Auto, DMX Regulated
Control	
● Protocols	DMX-512, RDM (Remote Device Management), Wireless (eoptional By LumenRadio)
● RDM configuration	DMX Setup, Fixture Status, RDM Commands (only DMX version)
● DMX Channels	5 / 1
● Display	Graphic OLED
● Software upload	Through DMX input (With RDM interface code AC10011A001)
Physical	
● Mounting options	Yoke
● Materials	Die-cast aluminium (Anti-Salt treatment)
● Framing System	Four blade framing system, each shutter blade is adjustable for radial position and angle
● IP Rating	IP65
● Color options	Black (standard), custom color on request (optional)
Optics	
BC10029A002	Profile Zoom 10°-25°
BC10029A000	Profile Zoom 14°-35°
BC10029A004	Profile Zoom 30°-60°
BC10029A005	Lens Tube Profile 80°
General accessories	
BC10028A000	Removable four blade framing system with gobo holder
BC10029A003	Frame Holder (included)
BC10029A100	LEDko EXT DMX wireless kit
RME34/G	DMX end of line closure cap (indispensable for the last projector of the line)

5 Channels

- 01 → Master Dimmer
- 02 → Spare Channel
- 03 → Dimmer Fine
- 04 → Strobe Effect
- 05 → Special Functions

1 Channel

- 01 → Master Dimmer - Color Temperature Settable by Display

Drawing Size

LEDko EXT 80° Optic

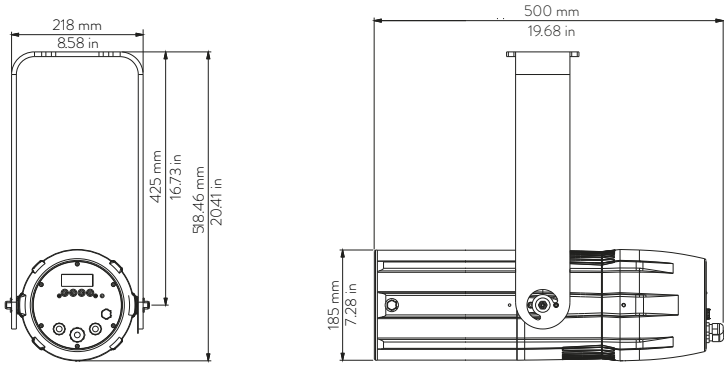

Length	Width	Height	Weight
500 mm 19.68 in	252.6 mm 9.94 in	185 mm 7.28 in	12.1 Kg 26.6lbs

With
bracket:
518.46 mm
20.41 in

LEDko EXT 30°-60° Zoom

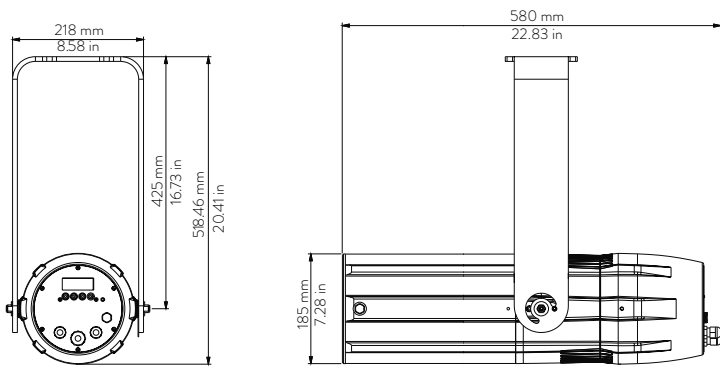

Length	Width	Height	Weight
580 mm 22.83 in	252.6 mm 9.94 in	185 mm 7.28 in	12.6 Kg 27.7 lbs

With
bracket:
518.46 mm
20.41 in

LEDko EXT 14°-35° Zoom

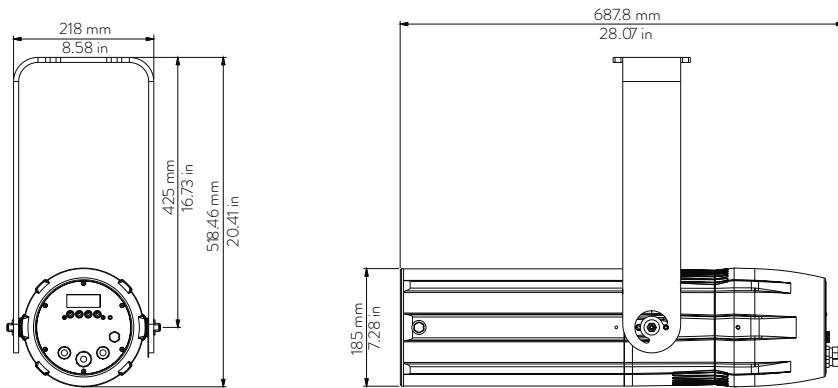

Length	Width	Height	Weight
687.8 mm 27.07 in	252.6 mm 9.94 in	185 mm 7.28 in	14 Kg 30.8 lbs

With
bracket:
518.46 mm
20.41 in

LEDko EXT 10°-25° Zoom

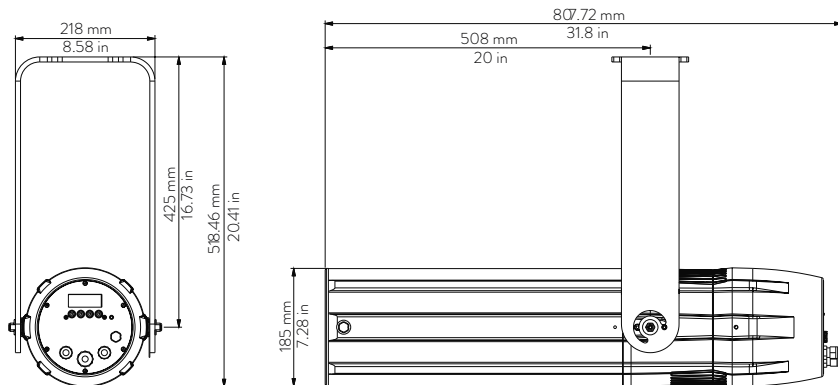

Length	Width	Height	Weight
807.2 mm 31.8 in	252.6 mm 9.94 in	185 mm 7.28 in	15 Kg 33.1 lbs

With
bracket:
518.46 mm
20.41 in

Mounting yoke attachment point

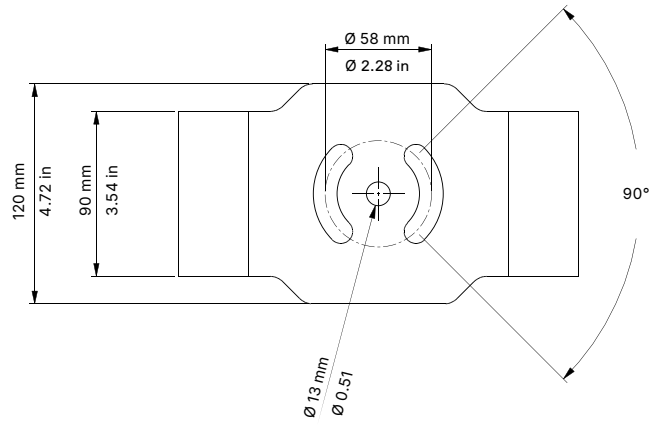

Accessories

Iris (optional)



DMX Signal Junction Connector

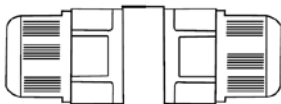

Specification

- DMX 512 STANDARD:
- Pin 1 = Ground Wire
- Pin 2 = Negative (Black)
- Pin 3 = Positive (White)



Architectural Outdoor - Louis Vuitton Fondatio, Paris, France

Product	LEDko EXT D
CCT	5.600K
CRI	>90



Architectural Outdoor - Champion Headquarters, Carpi, Italy

Product	LEDko EXT D
CCT	5.600K
CRI	>90

LEDko EXT Daylight CRI 90 - Profile Zoom 10°-25°

Optic: Minimum Zoom

Distance(m)	3	6	9	12	15	18	21	24	27	30	
lux	5.600K	37.640	9.410	4.182	2.353	1.506	1.046	768	588	465	376
Diameter Ø (m)	0,63	1,26	1,89	2,52	3,15	3,78	4,41	5,05	5,68	6,31	
lux	5.600K	CRI 90	TLCI 90								

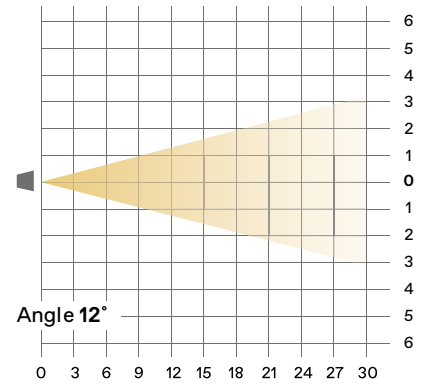

Optic: Medium Zoom

Distance(m)	3	6	9	12	15	18	21	24	27	30	
lux	5.600K	21.975	5.494	2.442	1.373	879	610	448	343	271	220
Diameter Ø (m)	0,90	1,79	2,69	3,59	4,48	5,38	6,28	7,17	8,07	8,97	
lux	5.600K	CRI 90	TLCI 90								

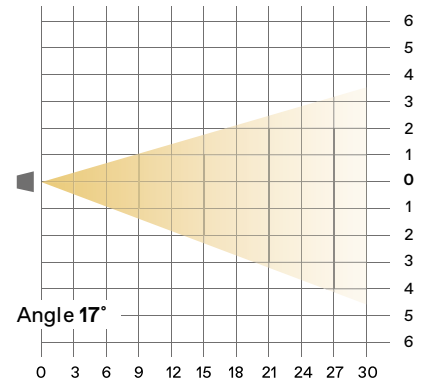

Optic: Maximum Zoom

Distance(m)	3	6	9	12	15	18	21	24	27	30	
lux	5.600K	14.410	3.603	1.601	901	576	400	294	225	178	144
Diameter Ø (m)	1,17	2,33	3,50	4,67	5,83	7,00	8,16	9,33	10,50	11,66	
lux	5.600K	CRI 90	TLCI 90								

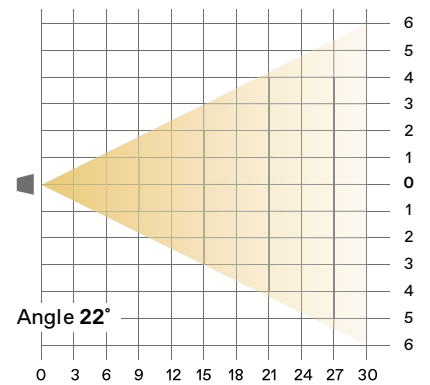

LEDko EXT Daylight CRI 90 - Zoom Profile 15°-35°

Optic: Minimum Zoom

Distance(m)	3	6	9	12	15	18	21	24	27	30	
lux	5.600K	23.222	5.806	2.580	1.451	929	645	474	363	287	232
Diameter Ø (m)	0,79	1,58	2,37	3,16	3,95	4,74	5,53	6,32	7,11	7,90	
lux	5.600K	CRI 90	TLCI 90								

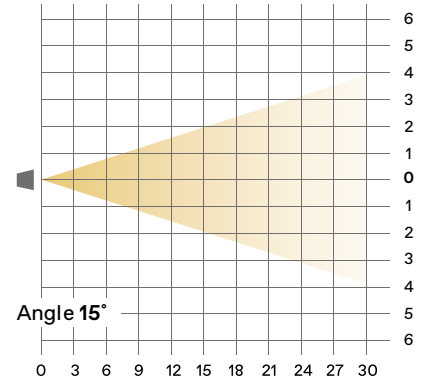

Optic: Medium Zoom

Distance(m)	3	6	9	12	15	18	21	24	27	30	
lux	5.600K	9.818	2.454	1.091	614	393	273	200	153	121	98
Diameter Ø (m)	1,28	2,55	3,83	5,10	6,38	7,65	8,93	10,20	11,48	12,75	
lux	5.600K	CRI 90	TLCI 90								

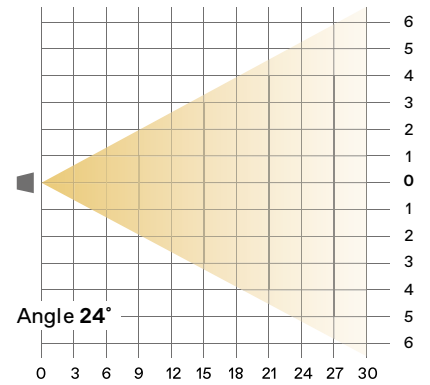

Optic: Maximum Zoom

Distance(m)	3	6	9	12	15	18	21	24	27	30	
lux	5.600K	5.573	1.393	619	348	223	155	114	87	69	56
Diameter Ø (m)	1,72	3,44	5,16	6,88	8,60	10,32	12,04	13,76	15,48	17,20	
lux	5.600K	CRI 90	TLCI 90								

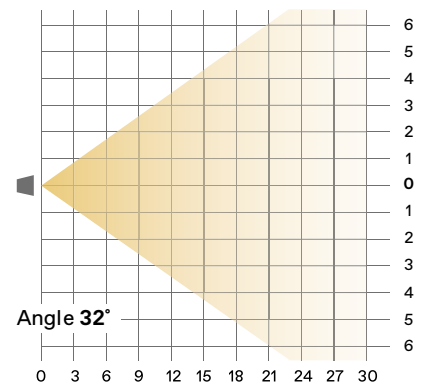

LEDko EXT Daylight CRI 90 - Zoom Profile 30°-60°

Optic: Minimum Zoom

Distance(m)	1	2	3	4	5	6	7	8	9	10	
lux	5.600K	80.000	20.000	8.889	5.000	3.200	2.222	1.633	1.250	988	800
Diameter Ø (m)	0,41	0,81	1,22	1,63	2,03	2,44	2,85	3,26	3,66	4,07	
lux	5.600K	CRI 90	TLCI 90								

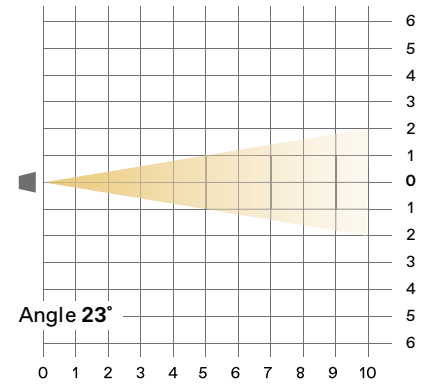

Optic: Medium Zoom

Distance(m)	1	2	3	4	5	6	7	8	9	10	
lux	5.600K	27.200	6.800	3.022	1.700	1.088	756	555	425	336	272
Diameter Ø (m)	0,81	1,62	2,42	3,23	4,04	4,85	5,66	6,46	7,27	8,08	
lux	5.600K	CRI 90	TLCI 90								

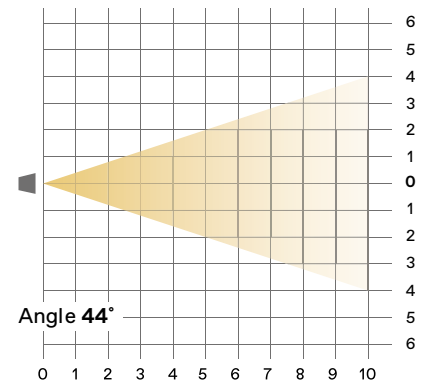

Optic: Maximum Zoom

Distance(m)	1	2	3	4	5	6	7	8	9	10	
lux	5.600K	20.732	5.183	2.304	1.296	829	576	423	324	256	207
Diameter Ø (m)	1,00	1,99	2,99	3,99	4,99	5,98	6,98	7,98	8,97	9,97	
lux	5.600K	CRI 90	TLCI 90								

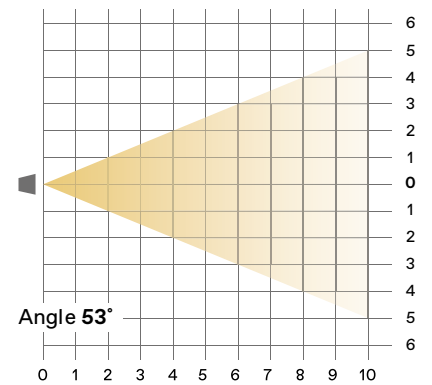

LEDko EXT Daylight CRI 90 - 80° Optic

Distance(m)	1	2	3	4	5	6	7	8	9	10	
lux	5.600K	11.000	2.750	1.222	688	440	306	224	172	136	110
Diameter Ø (m)	1,62	3,24	4,86	6,48	8,10	9,72	11,34	12,96	14,58	16,20	
lux	5.600K	CRI 90	TLCI 90								

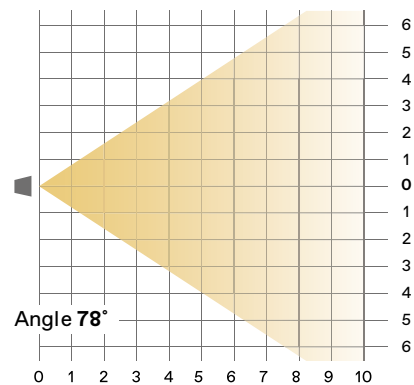

● Coemar Lighting S.r.l.

Via Carpenedolo, 90
46043, Castiglione delle Stiviere (MN) – Italy

P. +39 0376 1514412

M1. info@coemar.com

M2. service@coemar.com

W. coemar.com

P.iva – C.f. 02415330204

